

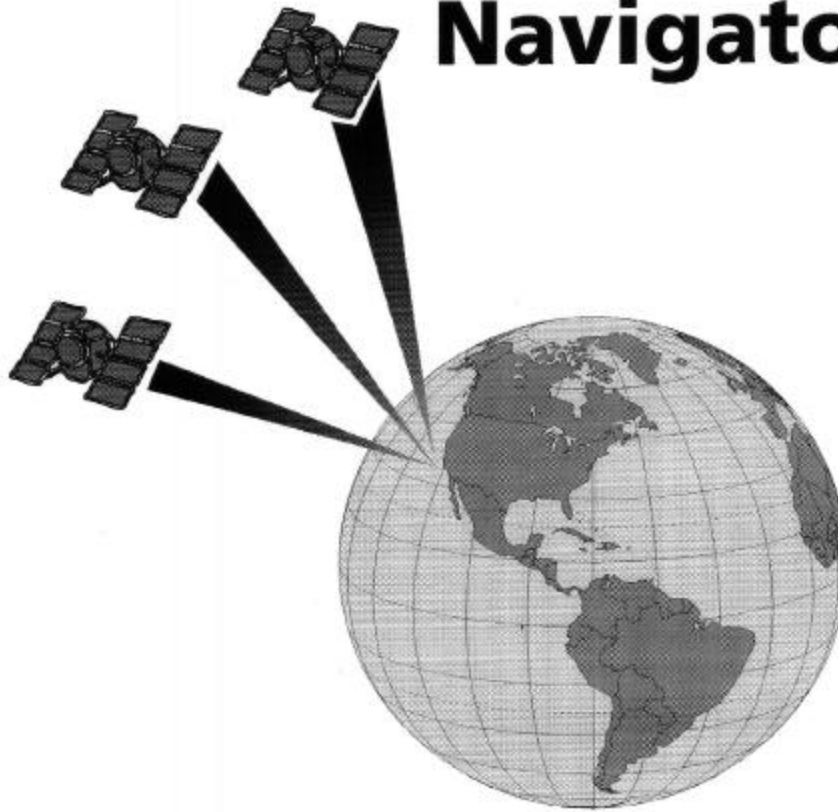



Magellan GPS Satellite Navigator



Reference Guide

Meridian XL & NAV 1200XL





 **WARNINGS**

USE GOOD JUDGEMENT

This product is an excellent navigation aid, but does not replace the need for careful orienteering and good judgement. Never rely solely on one device for navigating.

USE CARE

The Global Positioning System (GPS) is operated by the U.S. Government, which is solely responsible for the accuracy and maintenance of GPS.

The accuracy of position fixes can be affected by the periodic adjustments to GPS satellites made by the U.S. Government and is subject to change in accordance with the Department of Defense civil GPS user policy and the Federal Radionavigation Plan.

USE CAUTION

Accuracy can also be affected by poor satellite geometry. When the accuracy warnings appear on the screen, use the data with extreme caution.

USE PROPER ACCESSORIES

Use only Magellan cables and antennas; the use of non-Magellan cables and antennas may severely degrade performance or damage the receiver, and will void the warranty.

LICENSE AGREEMENT

Magellan grants you, the purchaser, the right to use the software supplied in and with MAGELLAN GPS products (the "SOFTWARE") in the normal operation of the equipment. You may make copies only for your own personal use and for use within your organization.

The SOFTWARE is the property of MAGELLAN and/or its suppliers and is protected by United States copyright laws and international treaty provisions; therefore, you must treat this SOFTWARE like any other copyright material.

You may not use, copy, modify, reverse engineer or transfer this SOFTWARE except as expressly provided in this license. All rights not expressly granted are reserved by MAGELLAN and/or its suppliers.

* * *

No part of this handbook may be reproduced or transmitted in any form or by any means, electronic or mechanical, including photocopying and recording, for any purpose other than the purchaser's personal use without the prior written permission of Magellan Systems Corporation.

© 1995 by Magellan Systems Corporation. All rights reserved.

Magellan™, GPS NAV 1200XL™, Meridian XL GPS™, and Backtrack™ are trademarks of Magellan Systems Corporation.

22-10211-000



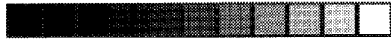

960 Overland Court, San Dimas, CA 91773
(909) 394-5000

22-10211-000





Table of Contents

Introduction	1
Packing List	1
Conventions Used In This Manual	2
Getting Started	3
General Description	3
Connecting Receiver Power	4
First Time Use - Initializing the Receiver	5
Proper Handling - Signal Reception	9
Taking your First Fix	10
Saving Your First Waypoint	11
Introduction to Routes	13
Creating a GOTO Route	14
Reference Section	15
General Usage	15
<i>Turning the Receiver Off</i>	15
<i>Inputting Data</i>	16
<i>Turning the Light ON and OFF</i>	16
NAV Screens	17
<i>Viewing the Position Screen</i>	17
<i>Viewing the NAV 1 Screen</i>	18
<i>Viewing the NAV 2 Screen</i>	18
<i>Customizing the Nav Screens</i>	19
PLOT Screens	21
<i>Viewing the POINTER screen</i>	21
<i>Viewing the PLOT Screen</i>	21
<i>Changing the Plotter Scale</i>	22
<i>Using PAN N SCAN</i>	22
<i>Setting a GOTO Using PAN N SCAN</i>	23
<i>Clearing Plotter Track</i>	23
<i>Viewing the ROAD Screen</i>	24
Waypoints	24
<i>Saving a Position Fix as a Waypoint</i>	24
<i>Creating a Waypoints</i>	26
<i>Accessing the Waypoint Menu</i>	26



<i>Viewing a Waypoint</i>	27
<i>Accessing the Waypoint Function Menu</i>	28
<i>Projecting a Waypoint</i>	28
<i>Editing a Waypoint</i>	29
<i>Deleting a Waypoint</i>	30
Routes	31
<i>Activating a GOTO Route</i>	31
<i>Accessing the Route Menu</i>	32
<i>Creating a Multileg Route</i>	32
<i>Activating and Deactivating a Route</i>	34
<i>Reversing a Route</i>	34
<i>Viewing the Route Summary (Edit Option)</i>	35
<i>Viewing the Legs of a Route</i>	35
<i>Inserting a Leg in a Route</i>	35
<i>Deleting a Leg</i>	36
<i>Adding a Leg</i>	37
<i>Replacing a Waypoint</i>	38
<i>Navigating (Activating) a Leg</i>	38
<i>Clearing a Route</i>	39
<i>Creating a MOB (Man OverBoard) Route</i>	39
<i>Creating a Backtrack Route</i>	40
<i>Creating a COORD Route</i>	40
<i>Viewing the LAST FIX Trip Summary Screen</i>	41
Last Fix Buffer	41
<i>Viewing a LAST FIX</i>	41
SETUP Options	42
<i>Initializing the Receiver</i>	42
<i>Setting the Coordinate System</i>	43
<i>Setting the Elevation Mode</i>	43
<i>Selecting Time Display</i>	44
<i>Setting Velocity Averaging</i>	44
<i>Setting Speed Units</i>	44
<i>Setting Distance Units</i>	45
<i>Setting Elevation Units</i>	45
<i>Setting North Reference</i>	45
<i>Selecting Map Datum</i>	45
<i>Setting NMEA</i>	45
<i>Selecting Baud Rate</i>	46
<i>Selecting Waypoint Sort</i>	46
<i>Selecting the Last Fix Interval</i>	46
<i>Plot Setup</i>	46
<i>Setting Alarms</i>	47





<i>Sampling</i>	47
<i>Light Intensity</i>	48
<i>Contrast</i>	48
Additional Features	49
<i>Viewing the SAT STATUS Screen</i>	49
<i>Viewing the Odometer</i>	49
<i>Resetting the Odometer and/or Trip Odometer</i>	49
<i>Viewing the Clock</i>	50
<i>Viewing the SUN/MOON Screen</i>	50
<i>Simulator</i>	51
<i>Erasing Last Fixes</i>	51
<i>Erasing Track from the Plotter Screen</i>	51
<i>Erase All Waypoints from Waypoint List</i>	52
<i>Clearing Receiver Memory</i>	52
Status Line Icons	53
Troubleshooting	54
Appendix	56
Optional Accessories	56
List of Available Datums	57
NMEA Attachment	58
City Reference Chart	63
Abbreviations and Data Terms	66
Specifications	68
Coordinate Systems	69
General Maintenance	72
Meridian XL	72
NAV 1200XL	74
The Global Positioning System	77
More Information on GPS	79
Glossary	81
Index	84



Menu Cross-Reference Guide

This guide displays the menus found in the Meridian XL/NAV 1200XL and the page number of this manual that the operation is described.

Function Menu

SAT STATUS	pg. 49
ROUTE MENU	pg. 32
WAYPOINTS	pg. 26
SETUP	pg. 42
SIMULATOR	pg. 51
ODOMETER	pg. 49
LAST FIXES	pg. 41
CLEAR MENU	pg. 51
CLOCK	pg. 50

Accessed by pressing the MENU key.

Route Submenu

ACTIVATE	pg. 34
REVERSE	pg. 34
EDIT	pg. 35
CLEAR	pg. 39

Accessed by pressing ENTER from the ROUTE MENU screen

Route Leg Menu

ADD LEG *	pg. 37
INSERT	pg. 35
DELETE	pg. 36
REPLACE	pg. 38
NAVIGATE	pg. 38

Accessed by pressing ENTER while viewing a route leg

* Displayed only for the last leg in a route

Clear Memory Menu

ERASE LFIXES ..	pg. 51
ERASE TRACK ...	pg. 51
ERASE WPTS	pg. 51
CLEAR MEMORY ..	pg. 51

Accessed from the Function Menu

NAV Popup Menu

SAVE POS	pg. 24
CREATE WPT	pg. 26
ROUTE MENU	pg. 32
CONTRAST	pg. 48
CUSTOMIZE * ...	pg. 19

Accessed by pressing ENTER from any NAV screen

* From PAN N SCAN screen only

PLOT Popup Menu

SAVE POS	pg. 24
CREATE WPT	pg. 26
ROUTE MENU	pg. 32
CONTRAST	pg. 48
PAN N SCAN * ...	pg. 22

Accessed by pressing ENTER from any PLOT screen

* From PAN N SCAN screen only



SETUP Menu

INITIALIZE	pg. 42
COORD SYSTEM ..	pg. 43
ELEV MODE	pg. 43
TIME FORMAT	pg. 44
VELOCITY AVG ..	pg. 44
SPEED UNITS ...	pg. 44
DIST UNITS	pg. 45
ELEV UNITS	pg. 45
NORTH REF	pg. 45
MAP DATUM	pg. 45
NMEA	pg. 45
BAUD RATE	pg. 46
WPT SORT	pg. 46
LFIX INTERVAL ..	pg. 46
PLOT SETUP	pg. 46
ALARMS	pg. 47
SAMPLING	pg. 47
LIGHT INTEN ...	pg. 48
CONTRAST	pg. 48

Accessed from the Function Menu

Waypoint Popup Menu

ESCAPE	pg. 28
EDIT	pg. 29
PROJECT	pg. 28
SUNRISE	pg. 50
DELETE	pg. 30

Accessed by pressing ENTER while viewing a waypoint from the waypoint list.

Odometer Popup Menu

ESCAPE	pg. 49
RESET TRIP	pg. 49
RESET ODOM	pg. 49

Accessed by pressing ENTER from the ODOMETER screen



SETUP Defaults

INITIALIZE	N/A	NMEA	OFF
COORD SYS	LAT/LON (DEG/MIN.00)	BAUD RATE	4800
ELEV MODE	2D	WPT SORT	ALPHA
TIME FORMAT	LOCAL AM/PM	LFIX INTERVAL	10 MINUTES
VELOCITY AVG	OFF	PLOT SETUP	
SPEED UNITS	KNOTS	TRACK	1.0
DIST UNITS	NM	ORIENTATION	HEADING UP
ELEV UNITS	FEET	ALARMS	ALL OFF
NORTH REF	MAGNETIC	SAMPLING	OFF
MAP DATUM	WGS84	LIGHT INTEN	HIGH
		CONTRAST	80%



Welcome from the Magellan crew.

With the purchase of a Magellan GPS satellite receiver, you have joined the thousands of people who enjoy using GPS in their professional and recreational activities.

Since we introduced our first product more than five years ago, Magellan has established a reputation for product excellence and customer support. Our customers include sailors, commercial fishermen, pilots, geologists, explorers, surveyors, and the Allied Forces in Desert Storm. Your receiver represents the next generation of GPS technology — technology that is combined with our hallmark durability and ease of use, which have evolved over years of field experience.

With your receiver are two documents: the *Reference Guide* and the *Field Guide*.

Like the Magellan GPS receiver, the *Field Guide* is tough and ready to go where ever your adventures take you. Printed on waterproof "paper", its purpose is to explain how to operate the receiver — in any weather. When not in use, the *Field Guide* fits neatly in the carrying case that is provided with the receiver.

The *Reference Guide*, which you are reading now, provides background information that will give you a deeper technical appreciation of the receiver and the GPS technology in general.

Wherever your outdoor recreation excursions take you, we hope your Magellan receiver will add to your fun and safety.

So that your experiences contribute to the next generation of Magellan receivers, I need to hear from you. All comments will be considered for incorporation into future products. Address your letters to me at Dept. 3-A.

Yours truly,

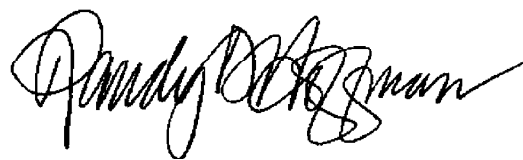

Randy D. Hoffman, President and CEO
Magellan Systems Corporation
Dept. 3-A
960 Overland Court
San Dimas, CA 91773





Introduction

Your Magellan GPS receiver has the advanced navigation features that experienced navigators expect, yet is simple enough for the novice navigator. This manual is broken up into four chapters; *Introduction*, *Getting Started*, *Reference*, and *Appendix*. It is very important that you go through the *Getting Started* chapter first as it prepares your receiver for use and provides some basic instruction for getting you up and running with your GPS receiver.

The third chapter is a *Reference Section* for the features found in your receiver including step-by-step instructions on their use. Because of the advanced navigational features of the receiver some of the terminology used in these procedures may be new to you, but don't let that slow you down. As you use the receiver such terms as waypoints, leg, route, etc. will quickly become familiar.

The final chapter of this manual, *Appendix*, contains some further explanations and information that will help you use your receiver and defines many of the terms that may be unfamiliar.

Packing List

The following items should be in your package:

- GPS satellite navigator (Meridian XL or NAV 1200XL)
- Reference guide
- Field guide

[Meridian XL Additional Items]

- Carrying case
- Lanyard strap

[NAV 1200XL Additional Items]

- Mounting bracket with knobs
- Mounting template (for flush mounting)
- Antenna and mast mount (with 20 ft. of cable)
- Power/Data Cable

If any of these items is missing, please contact your local Magellan dealer or distributor.



Conventions Used In This Manual

This manual applies to both the Magellan NAV 1200XL (a panel mount receiver) and the Magellan Meridian XL (a hand-held receiver). When an option or technique is applicable to only one of the receivers, it will be preceded by "[NAV 1200XL]" or "[Meridian XL]."



WARNING: Warning messages will occur to alert you to potential problems that may be encountered if you do not follow the directions carefully.



NOTE: Note messages are shown to provide important information that will assist you in understanding your Magellan receiver and its operation.

If you are following along with your receiver during the step-by-step instructions, you should make key presses whenever the key name is in **bold** text. Text where the key name is not bolded is informational but can be pressed if you desire.

The Reference section of this manual is divided up into the various operations that you can perform with your receiver. Each section is titled with the operation to be performed, a brief description of the operation and how it might be used, a graphic display of the key presses to be used as a "quick reference" for the operation, and a detailed description of the operation with the screens shown for clarity.

After you have used your receiver for a short period of time you will find that you will need to refer to this manual less and less and the graphic displays of the key presses will be all you will need to remind you of the steps required.

Getting Started

General Description

The Meridian XL is a self-contained hand-held GPS receiver designed for general purpose position locating and navigation. It has a removable quadrifilar antenna located on the upper right side of the receiver, a high-contrast backlit LCD, and keypad. Using three AA batteries, inserted from the battery door found behind and near the base of the receiver, the Meridian XL will operate continuously for up to 4.5 hours.

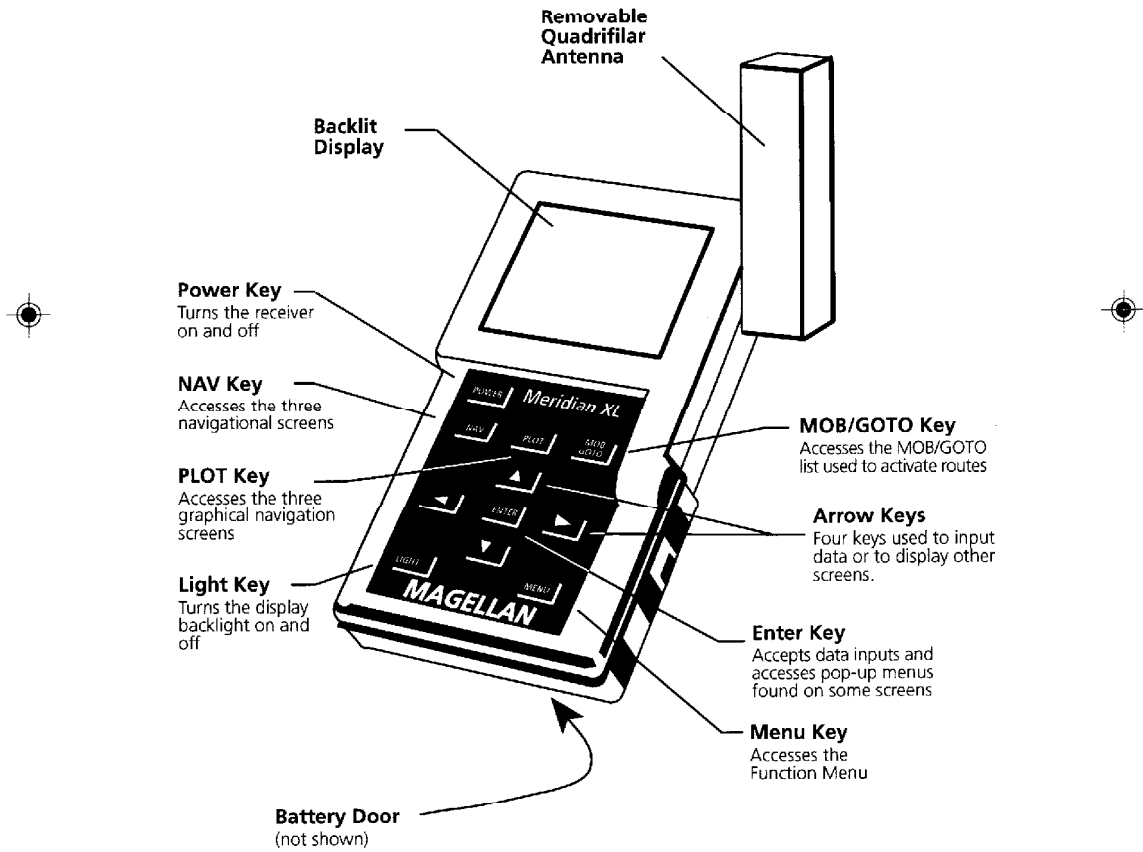

Meridian XL

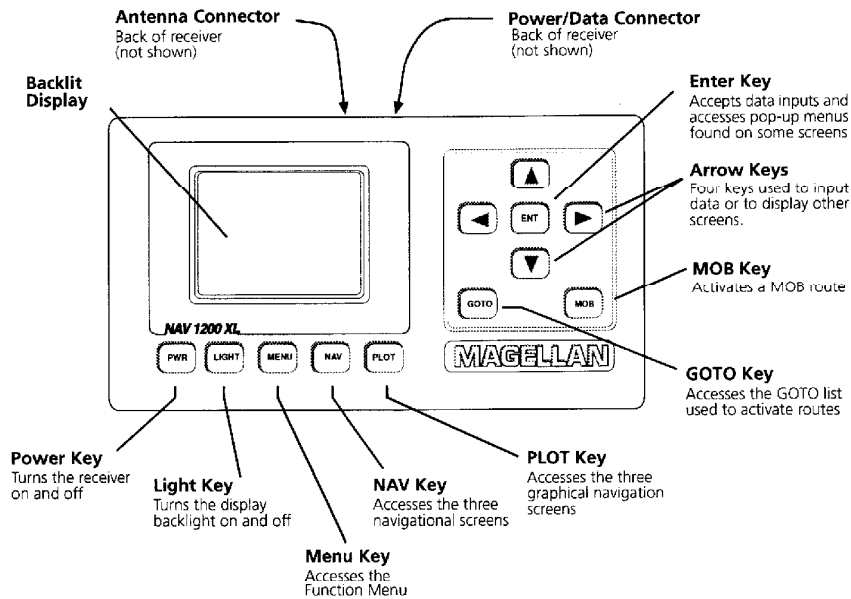

NAV 1200XL

Receiver Accuracy. Before beginning, just a few words on the accuracy of your receiver. The satellite constellation used to provide the GPS information that your receiver uses was put into orbit and is maintained by the Department of Defense (DoD) for use by the U.S. armed forces and its allies. GPS positioning for general use produces an accuracy of 25 meters or better, far more accurate than anyone anticipated. Since the signals generated by these satellites are accessible to anyone, the DoD has introduced errors into the signals sent by the satellites for security reasons. These errors are referred to as Selective Availability (or SA).

At present, your GPS position will be accurate to within 100 meters horizontally and 150 meters vertically. This accuracy can be improved by using Differential GPS (DGPS), which is described later in the manual. SA means that 95% of the time, your horizontal coordinates will be within 100 meters of your actual position. Elevation may vary even further.

Connecting Receiver Power

[Meridian XL] Connecting Power to the Meridian XL. The Meridian XL receiver operates on either three AA batteries or a 9-16 volt DC external power source. Before using the Magellan Meridian XL GPS receiver, you need to install the batteries by removing the battery compartment door as shown. While the battery compartment was designed to be moisture

resistant, it is not sealed and will not prevent moisture from entering with prolonged exposure. Even when operating the Meridian XL with external power, the batteries are required to prevent loss of data if you should lose external power for any reason.

Insert the batteries as shown in the receiver and reinstall the battery cover. You are now ready to turn the receiver on.

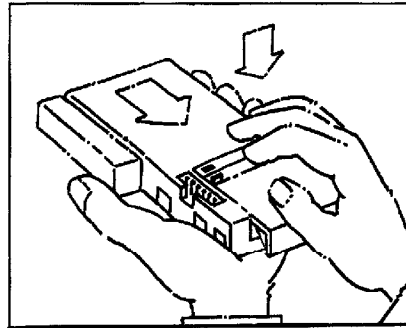

[Meridian XL] The receiver's memory has internal protection for power loss of up to 10 minutes. This allows you to change the batteries without losing the receiver's memory provided that you change the batteries within the 10 minute time frame.

[NAV 1200XL] Connecting the NAV 1200XL to External Power. Please refer to *General Maintenance* found in the appendix for instructions on connecting external power and the antenna to the NAV 1200XL.

First Time Use - Initializing the Receiver

Turn the receiver on by holding down the **POWER** key until the start-up screens appear, release and wait for the *POSITION* screen to be displayed. The *POSITION* screen tells you the coordinates of your present position. Right now, unless your receiver has been initialized by your dealer, it is displaying a default null position. That is because the receiver requires more information before it can be used as a navigational tool. The constellation of 24 GPS satellites circling the globe is in constant motion and before your receiver can tell you where you are, it needs to know where the satellites are relative to itself. It does this with the use of an almanac where it has stored in memory a general location and a time and date. The almanac tells the receiver which satellites are in view. Using the location and time you enter, the receiver determines a more accurate location using the satellites.

The problem, now, is that the receiver doesn't know its approximate location, so it doesn't have a reference point in selecting which satellites to use. Without knowing its approximate location, the receiver may take



20 minutes or more to find your current position. Telling your receiver the initial position, time and date is called *initializing* your receiver; initializing enables it to begin tracking satellites, and therefore, calculating your position, much faster.

You do not need to initialize your receiver each time you use it. Follow these steps to initialize the Meridian XL or NAV 1200XL if the receiver memory has been cleared (indicated by LAT/LON coordinates of 00°00.00N, 000°00.00W when you turn the receiver on) or if the receiver has been transported more than 300 miles while turned off.

Inputting Approximate Position. As discussed earlier, your receiver will obtain its initial position fix a lot quicker if it has an approximate idea of its current location. What you need to do now is to enter the latitude, longitude, date, and time of where you are now. While you probably know the date and time, it is unlikely that you know the latitude and longitude coordinates of your present position, so we have provided you with a City Reference Chart in the appendix of this reference guide. Find the chart and locate the city that is closest to you.

What you are going to do next is input the coordinates of the city you have selected. This will give your receiver an approximate location to use as a starting point for tracking satellites. This will greatly shorten the time it will take the receiver to get your position for the first time (referred to as Time To First Fix). If you want, you can write down the latitude and longitude of the city in the space provided here.

City _____

Latitude: _____ Longitude: _____

For purposes of explanation, the coordinates for Los Angeles, California (34°17N - latitude and 118°39W - longitude) will be used in this example, but you should input the coordinates that you found on the City Reference Chart.



Using latitude and longitude will satisfy most of the users of this receiver, but you may use any of the other coordinate systems (UTM, OSGB, TDs, British Grid, Swiss Grid, or Swedish Grid) to initialize the receiver. If you prefer one of these coordinate systems, select the desired coordinate system in the COORD. SYSTEM section of Setup, then access INITIALIZE. You will be prompted to enter the appropriate data in the format of the chosen coordinate system.

Initialize the Receiver

Press **MENU** and use the **DOWN ARROW** to highlight SETUP. Press **ENTER**.



The *SETUP MENU* is displayed with the menu option INITIALIZE highlighted. Press **ENTER**.

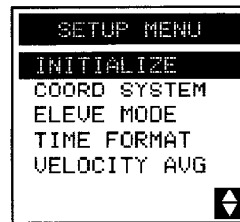

The first character in the latitude line (first line) is highlighted, indicating that it can be changed.

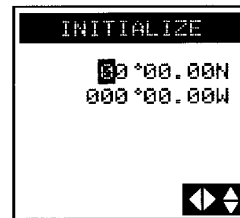

Press the **UP ARROW**. Notice that the highlighted number has incremented by one. Keep pressing the **UP ARROW** until the first digit matches the first number you found for latitude. If you go past the number you want, you can use the **DOWN ARROW** to step down or continue using the **UP ARROW** and loop through the number sequence. When the correct number is displayed, press the **RIGHT ARROW** to step to the second digit on the latitude line.

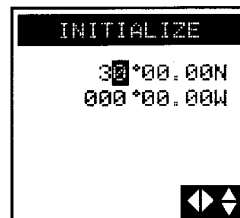

What's important to remember here is that the UP/DOWN ARROWS step up or down through the numbers and the LEFT/RIGHT ARROWS move the highlight to the left or right.

Continue entering the latitude. When it matches the latitude found on the City Reference Chart, use the **RIGHT ARROW** to highlight the "N" at the end of the latitude line. Latitude may be north "N" or south "S" and may be changed, if necessary, by using the UP/DOWN ARROW. Once the latitude is correct, press **ENTER**.

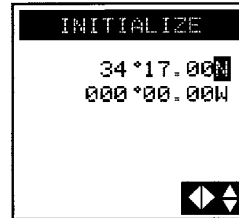

The cursor (highlighted area) has now jumped down to the first character on the longitude line. Following the same procedure as before, enter the longitude for the city you found on the chart.

Your display should now resemble the one shown to the right. If all of the information for the latitude and longitude is correct, press **ENTER**. (If you notice now that you made a mistake in the latitude, press MENU, highlight SETUP and press ENTER. Select INITIALIZE, press ENTER and start over.)



The receiver will prompt you for your local elevation. Use the **UP/DOWN** and **LEFT/RIGHT ARROWS** to input your approximate elevation and press **ENTER** to confirm, or if you do not know your elevation, simply press **ENTER** to confirm the default value.

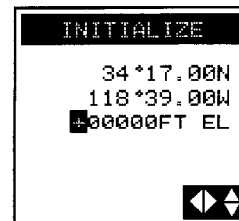

If this is not the first time you have used your receiver, or if it is the first time but your receiver has already begun acquiring signals from a sufficient number of satellites, the following time and date entry may not be displayed.

Input your local time in 12-hour AM/PM format. **Take extra care to input the time correctly (to within 10 minutes), including the AM/PM designator.** Use the **ARROW KEYS** to change the time. Use the **UP/DOWN ARROWS** to change "AM" to "PM" if necessary. When the time is correct, press **ENTER**.

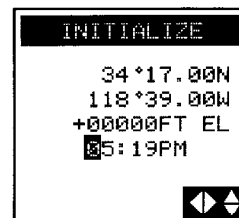

Your receiver requires just one more piece of information and that is the date. Use the **UP/DOWN ARROWS** and **LEFT/RIGHT ARROWS** to set the correct date. Your display should resemble the one shown at right. Double-check all of the information entered. Then, press **ENTER**. (If you notice now that you made a mistake, press **MENU**, highlight **SETUP** and press **ENTER**. Select **INITIALIZE**, press **ENTER** and start over.)

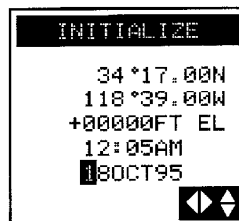

The receiver is now ready to perform one of its primary functions, providing you with your current position.

Proper Handling - Signal Reception

The illustrations show both the proper and improper placement of a fixed antenna on a boat. Also, the fellow trying to get a position fix on the deck of the boat would get better signals if he would move up to the bridge. Physical obstructions (buildings, large trees, etc.) will block satellite signals from reaching the receiver. If unable to get a position fix, move the receiver so it has a clearer view of the sky, allowing it to choose from all of the satellites currently available.

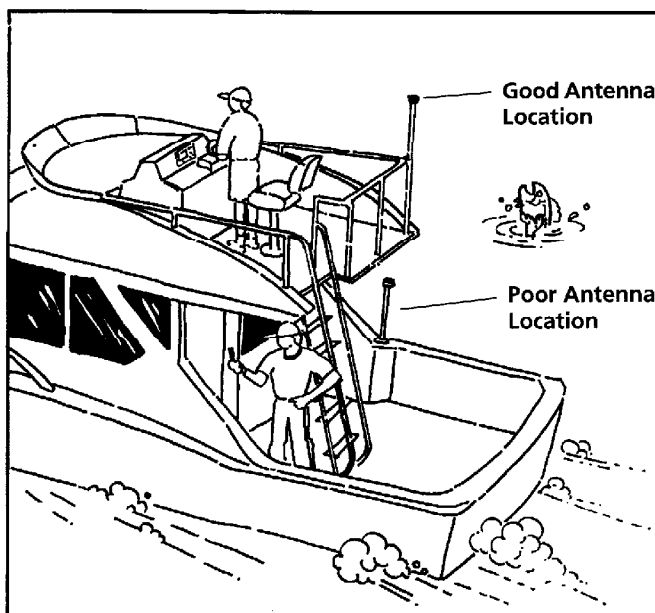

Taking your First Fix

To get a position fix, you must be outside with a clear view of the sky and away from any large obstructions (buildings, large trees, etc.).

[Meridian XL] Rotate the antenna upward and hold the receiver in a comfortable position.

[NAV 1200XL] Ensure that the external antenna is installed where it has a clear view of the sky and that it is properly connected to the receiver.

If the receiver is off, press the **POWER** key to turn the receiver on, or if you have just finished initializing the receiver, press the **NAV** key until the screen showing your coordinates is displayed. This screen is called the *POSITION* screen.

[NAV 1200XL] The NAV 1200XL has a backup lithium battery that will retain the receiver's memory while the receiver is turned off.

The *POSITION* screen appears with the latitude, longitude, and elevation that you entered in during INITIALIZE. The word "SEARCHING" appears indicating that the receiver is searching the sky for satellites.

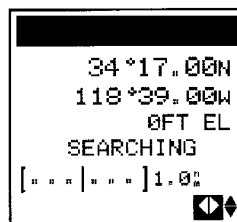

In a short period of time, the receiver will locate the satellites and begin receiving information. The first indication of this is that "SEARCHING" is replaced with a bar graph indicating the receiver's progress toward acquiring GPS data from the satellites.

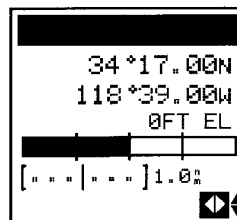

Within a few minutes, the bar graph will disappear and be replaced with the local time. This indicates that your receiver is receiving GPS information and has computed your present position. Everything that you do from now on is based on the position information received.

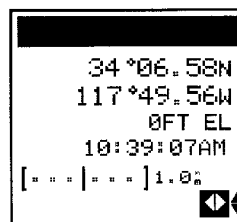

Saving Your First Waypoint

You now have a position fix that defines your current location. During normal operation your receiver continuously computes your position and displays that information on the *POSITION* screen.

You can save this position in the receiver's memory for use later on. This stored fix is referred to as a waypoint. A useful way to record this would be to assign a unique name to the position. That way, if you were to go to a new location you could use your receiver to guide you back to your current location.

Press **NAV** or **PLOT** (which will take you to a **NAV** or **PLOT** screen if you are not already there), then press **ENTER**, highlight **SAVE POS** and press **ENTER**. This tells the receiver that you want to store the current position as a waypoint. The cursor is in the upper left corner, and the arrows displayed in the lower right corner of the screen indicate that it is in the edit mode. What you will do next is assign a name to this position.

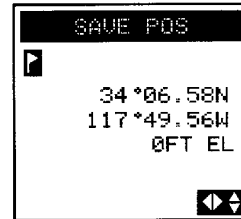

The waypoint name can be created by the receiver or you can input a name that means something to you. If you press **ENTER** without creating a name, the receiver automatically assigns a waypoint name. Waypoint names assigned by the receiver appear in the format φ WPxxx, where the xxx is a sequential number (001, 002 etc.).

To allow the receiver to name the waypoint automatically, press **ENTER**. The following screen will appear briefly and then the receiver returns to the *POSITION* screen.

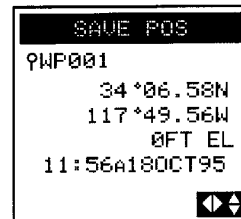

All waypoint names begin with an icon. You have the option of choosing one of nine different icons: a right flag (▶), a left flag (◀), a diamond (◆), a double box (▣), an anchor (⚓), a square (■), a diving symbol (⚓), a fish (🐟), or a target (⊕). Unless you select a different icon, unit-generated waypoint names use a pin (📍) icon. These icons will be used to display the relative location of the waypoint on the *PLOT* screen and the *ROAD* screen (described later).

Now you will save the same position as above, but this time you will assign a name to the waypoint.

Press **ENTER**, highlight SAVE POS and press **ENTER** again. Select an icon by pressing the **UP** or **DOWN ARROW**.

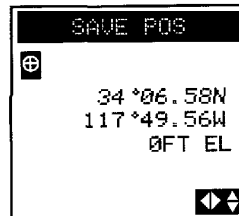

Selecting CREATE WPT instead of SAVE POS will allow you to enter a waypoint exactly as described above with the additional option of changing the latitude, longitude, and elevation of the position. (See Creating Waypoints)

Press the **RIGHT ARROW**. This moves the cursor one space to the right. Select the letter "D" by using the **UP/DOWN ARROWS**.

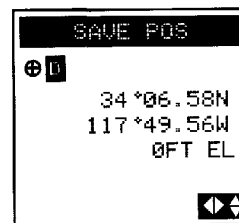

Press the **RIGHT ARROW** moving the cursor again one character to the right. Select the letter "O" by using the **UP/DOWN ARROWS**.

A little trick in scrolling quickly through the letters and numbers in the edit cursor is to hold down the UP or DOWN ARROW key. The characters scroll by every third character. When you are near the character you want, release the arrow key and step one character at a time.

Continue using the **RIGHT ARROW** to move the cursor and the **UP/DOWN ARROWS** until you have spelled out the word "DOCK" and your screen appears like the one shown. (Remember, your position information will be different from what is displayed here.)

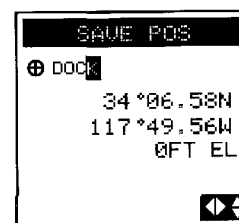

Press **ENTER**. The screen to the right will appear briefly and then the display will return to the *POSITION* screen

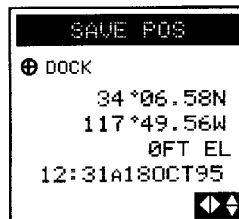

Introduction to Routes

A route is a planned course of travel defined by a series of waypoints. To create a route, you select waypoints that you have stored in the receiver's memory. These waypoints are then connected to form the segments or "legs" of the route. A route may contain from one to fifteen legs.

Suppose you were on a fishing trip in the area shown below. You want to go from the dock to the bait shop, then across to the inlet on the island. Before you start, turn the receiver on and let it get a position fix. Once you have a fix, save it as a waypoint. That way you'll be able to create a route back to the dock at the end of the day, even if darkness or weather conditions (cloud cover, rain, etc.) make it difficult to use your own navigation skills.

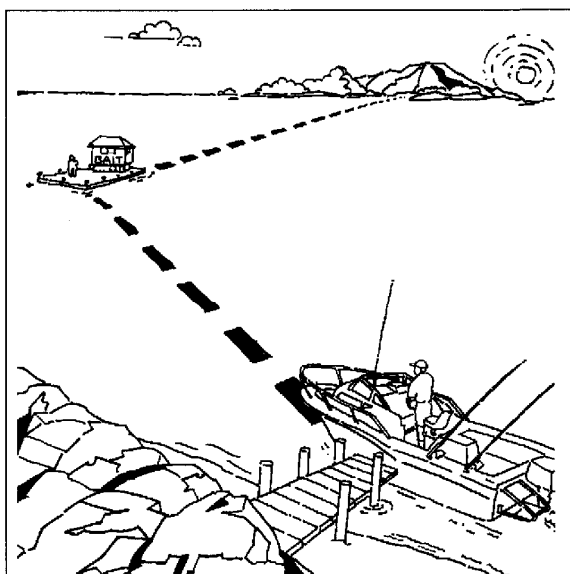

In addition, you can instantly create a one-leg route called a GOTO. This route uses your present position as its start and any waypoint you select that you have saved in memory as the destination. The following will show you how simple it is to create a GOTO route. In this example we have stored a waypoint in memory and named it "■JETTY."

 If the receiver has not yet computed a position fix, then the start of the GOTO may not represent your current position. It will, however, correct the navigation information after a position fix is acquired.

Creating a GOTO Route

After computing a position fix, press **GOTO**. Use the **UP/DOWN ARROWS** to highlight the waypoint that represents your destination.



The first four selections in the GOTO menu allow you to create a Man OverBoard (MOB), Backtrack, or Coordinate route or to activate an existing route; they are discussed in the Reference Section.

Press **ENTER**. The receiver begins navigating toward the selected waypoint and the display returns to the last viewed NAV screen. Note that the destination is now placed in the header bar of the NAV screen.

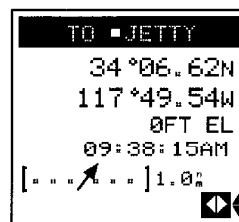

 It is necessary to have a current position fix in order for the receiver to compute navigation information. If you do not have a position fix, the navigation information will be displayed with dashes until a position fix is acquired.



Reference Section

This section explains the various functions of your receiver and is organized by function or topic rather than by menu. To perform a given function, refer to the Table of Contents and the Menu Cross Reference Guide in order to quickly locate that section.

General Usage

The receiver is used to compute coordinate positions which are stored as named waypoints and used to create routes. Waypoints can be viewed, edited, and projected to create new waypoints, or deleted. Routes can be created, activated, deactivated, reversed, edited and cleared. This section covers these and other functions which will enable you to take full advantage of your receiver's capabilities.

Turning the Receiver On



Press the **POWER** key and hold for three seconds. If the batteries are installed correctly (Meridian XL) or the external power is properly connected (Meridian XL and NAV 1200XL), the copyright and Magellan displays will quickly flash on the screen, followed by the *POSITION* screen.



If these screens do not appear, please check that the battery installation and/or external power is properly connected and turned on.

Turning the Receiver Off



To turn the receiver off, press the **POWER** key. The *POWER DOWN* screen is displayed for five seconds. Pressing the **POWER** key again before the counter reaches 1 will cause the receiver to turn off immediately; pressing any other key will stop the receiver from turning off.

Inputting Data



Moves the cursor
one space, left or
right



Scrolls through the
icons or
alphanumeric list

The UP/DOWN and LEFT/RIGHT ARROWS have two functions depending on how the ARROW ICONS are displayed in the bottom right corner of the various screens.

While on some screens the UP/DOWN or LEFT/RIGHT ARROWS are used to access additional pages, on other screens they allow you to input data, such as waypoint names or coordinates, or to select menu items.

The ARROW ICONS in the status line indicate which mode is currently being used. Whenever there are additional screens to view from the one displayed, the receiver shows normal arrow icons (◀▶) in the lower right corner of the display. A second type of arrow may be displayed in the lower right hand corner. These arrows are similar to the first, but are displayed in reverse video (▶◀) and are referred to as "input" or "edit arrows." When these reverse video arrow icons appear, the arrow keys are used to enter data or make selections on the current display, rather than to move from screen to screen.

Turning the Light ON and OFF

To activate the display light, press the LIGHT key. To deactivate the display light, press the LIGHT key again.

LIGHT

The receiver will indicate that the light is on with a light bulb icon (💡) in the status line next to the arrow icons.

The display light causes an increase in battery drain resulting in shorter battery life.

Brightness level can be adjusted (LOW/HIGH) in the SETUP MENU.

NAV Screens

The three NAV screens accessible from the NAV key are the *POSITION*, *NAV 1* and *NAV 2* screens. You may scroll through these screens using the NAV key or the UP/DOWN ARROWS. Press NAV until the *POSITION* screen is displayed.

Viewing the *POSITION* Screen

The *POSITION* screen displays the coordinates and elevation of the current position in a larger format so that they may be easily viewed from a distance.

The *POSITION* screen, like the *NAV 1* screen, shows a CDI (course deviation indicator). The straight line is the course marker, and the current position is represented by the arrow. If the arrow is to the left of the course marker, you are to the left of the course line. The number next to the CDI is the CDI scale, or the distance from the course line at the center to either end of the CDI. (Pressing the LEFT/RIGHT ARROWS changes the CDI scale.)

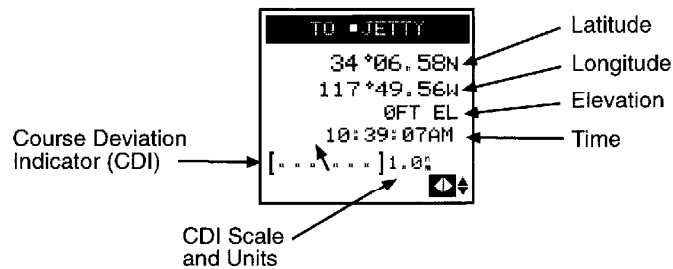

POSITION Screen Using LAT/LON Coordinate System

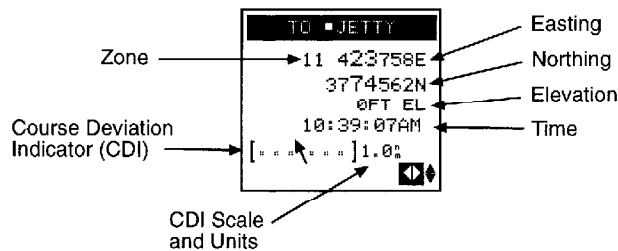

POSITION Screen Using UTM Coordinate System

Viewing the NAV 1 Screen

Press the **NAV** key until the **NAV 1** screen appears, showing BRG, DST, COG and SOG. NAV 1, the first navigation screen, provides you with information about your speed and direction of movement. If a route is active, the **NAV 1** screen also tells you where you are in relation to the destination and course line, and displays the name of the destination waypoint of the active leg in the title bar.

In the bottom corner of the **NAV 1** screen is a CDI (course deviation indicator), which is a graphic representation of cross track error, or how far off course you are. The straight line is the course marker, and the current position is represented by the arrow. If the arrow is to the left of the course marker, you are to the left of the course line. The number next to the CDI is the CDI scale, or the distance from the course line at the center to either end of the CDI. Pressing the LEFT/RIGHT ARROWS changes the CDI scale. Select from 0.2, 0.4, 1.0, 2.0, 4.0, or 8.0 distance units.

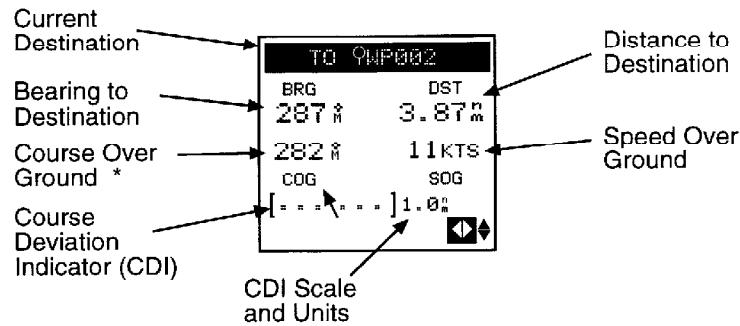

* Displays dashes if receiver is stationary (<1 knot)

The default fields include bearing (BRG) to the active waypoint, Distance (DST), course over ground (COG) and speed over ground (SOG), or using customize, you may select VMG (velocity made good), SOA (speed of advance), ETA (estimated time of arrival), ETE (estimated time en route), XTE (cross track error), STR (steering), CTS (course to steer) or a blank line. (See Customizing the Navigation Screens.)

Viewing the NAV 2 Screen

Press **NAV** again, or use the **DOWN ARROW** to scroll to the **NAV 2** screen.

The **NAV 2** screen displays three additional information fields which can also be customized.

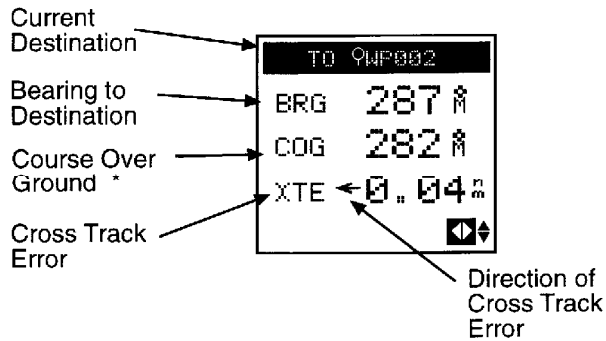

* Displays dashes if receiver is stationary (<1 knot)

Information is displayed in a large format so that it may be easily viewed from a distance. All of the fields can be customized; default fields include bearing (BRG) to the active waypoint, course over ground (COG) and cross track error (XTE), or you may select VMG (velocity made good), SOA (speed of advance), SOG (speed over ground), ETA (estimated time of arrival), ETC (estimated time en route), DST (distance), XTE (cross track error), STR (steering), CTS (course to steer) or a blank line. Cross track error (XTE) is displayed as a numeric value. The arrow next to XTE indicates the direction of the error, left or right of the course line.

Customizing the Nav Screens

As previously mentioned, NAV 1 and NAV 2 screens can be customized to display the data fields you find most convenient for navigation.

When you access these two screens for the first time, the fields shown are the default choices. The NAV 1 screen displays BRG, DST, COG and SOG fields, while the NAV2 screen displays BRG, COG and XTE fields.

Available options include:

- BRG Bearing to the active waypoint
- DST Distance to the active waypoint
- SOG Speed Over Ground
- COG Course Over Ground
- ETA Estimated time of arrival to the active waypoint
- ETE Estimated time en route to the active waypoint
- VMG Velocity made good toward active waypoint
- XTE Cross track error
- SOA Speed of Advance toward active waypoint
- CTS Course to steer
- STR Steering

Press the **NAV** key from any screen to view a NAV screen. Press **NAV** again as necessary to display either the *NAV 1* or *NAV 2* screen.

Press **ENTER** to display the pop-up menu.

Use the UP/DOWN ARROWS to highlight CUSTOMIZE and press **ENTER**.



The pop-up menu disappears and the display returns to the NAV screen from which you came.

NAV 1 screen

When the pop-up menu disappears and the display returns to the *NAV 1* screen, the first field is highlighted. (The first default is BRG, but another option may appear if you have previously customized the fields.)

Use the **UP/DOWN ARROWS** to select the field to edit, and the **LEFT/RIGHT ARROWS** to scroll through the various options.

After you have selected an option, press the **UP/DOWN ARROWS** to move to the next field, where you scroll through the list of options again using the **LEFT/RIGHT ARROWS**.

When you have finished selecting all of the options you wish to include in the *NAV 1* screen display, press **ENTER** to exit and save the selections.

NAV 2 screen:

When the pop-up menu disappears and the display returns to the *NAV 2* screen, the first default field heading "BRG" is highlighted.

Use the **UP/DOWN ARROWS** to select the field to edit, and the **LEFT/RIGHT ARROWS** to scroll through the various options.

After you have selected an option, press the **UP/DOWN ARROWS** to move to the next field, where you scroll through the list of options again using the **LEFT/RIGHT ARROWS**.

When you have finished selecting all of the options you wish to include in the *NAV 2* screen display, press **ENTER** to exit and save the selections.

PLOT SCREENS

Three graphical screens can be accessed from the **PLOT** key: the *PLOT* screen, the *ROAD* screen and the *POINTER* screen. You may scroll through these three screens by pressing the **PLOT** key repeatedly once you have accessed one of the *PLOT* screens or by using the **UP/DOWN ARROWS**. Press **ENTER** from any of these three screens to display the pop-up menu.

Viewing the *POINTER* screen

Access the *POINTER* screen by pressing the **PLOT** key (twice or three times, if necessary). This screen graphically displays the TO destination waypoint of the current leg if there is an active route or GOTO and the bearing and distance to that waypoint. An arrow inside the arc points toward the destination of the active leg, shown as a waypoint icon.

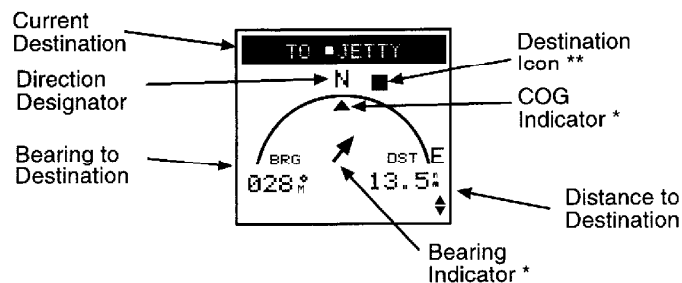

* Displayed only if receiver is moving

** The destination icon disappears if it extends past the displayed arc (is behind you).

Viewing the *PLOT* Screen

This screen plots your route on the display using the arrow icon to display your relative position on the route. Your track is also displayed, allowing you to follow your movement in relation to the course.

Press the **PLOT** key as necessary to access the *PLOT* screen. If many of the waypoints you have created are contained in the current display range, the screen may take several seconds to redraw. (If the screen does not look similar to the shown on the following page after several seconds, press the **PLOT** key repeatedly to scroll through the sequence.)



The *PLOT* screen displays "TO destination waypoint" of the current leg if there is an active route or GOTO, and the bearing and distance to that waypoint.

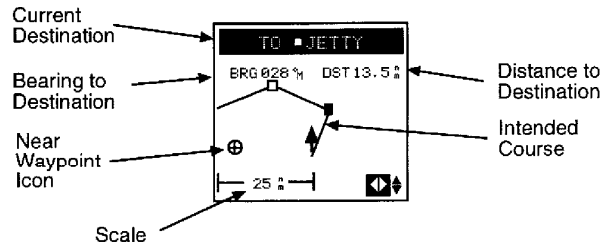

Changing the Plotter Scale

Press the **LEFT/RIGHT ARROWS** to adjust the scale, shown at the bottom left corner of the screen.

Using PAN N SCAN

The *PLOT* screen is equipped with a PAN N SCAN feature that allows the user to access waypoint information by positioning the cursor over the waypoint. (To access the *PLOT* screen you may need to press the PLOT key several times to scroll through the sequence.)

From the *PLOT* screen, press **ENTER** to access the pop-up menu. You will notice that this menu is different from the pop-up menu accessed from other screens in that it has an additional feature, PAN N SCAN.

Using the **UP/DOWN ARROWS**, highlight PAN N SCAN and press **ENTER**.



The *PAN N SCAN* screen is similar to the *PLOT* screen, however a vertical and horizontal line cross to form a cursor. The bearing (BRG) and distance (DST) from your present position to the cursor are displayed at the top of the screen.

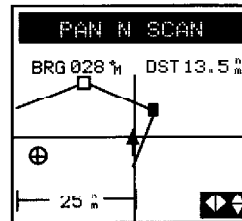

Use the **UP/DOWN** and **LEFT/RIGHT ARROWS** to move the cursor anywhere on the screen or to scroll off the screen to view portions of the active route not currently shown on the screen.



When the cursor covers a waypoint icon on the screen, the title bar displays the name of that waypoint and, just below, the bearing and distance to the waypoint.

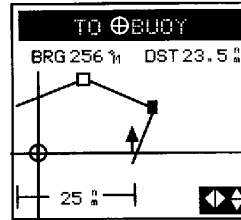

Setting a GOTO Using PAN N SCAN

When the cursor is on an icon and the waypoint information is displayed, press **ENTER**.

A GOTO confirmation screen appears with the heading GOTO WAYPOINT and the options YES and NO. Select YES to create the GOTO and return to the PLOT screen, or NO to return to the PAN N SCAN screen, and press **ENTER**.

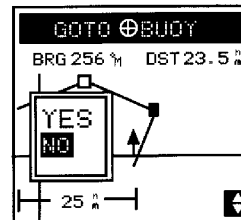

To exit the PAN N SCAN screen, press **ENTER** when no waypoint is covered by the cursor. The display returns to the PLOT screen.

Clearing Plotter Track

As you use your receiver more, you may soon notice the PLOT screen becoming cluttered with the graphic display of your past movement (track). You can erase the track display with the ERASE TRACK option in the Clear Menu. Press **MENU** and use the **UP/DOWN ARROWS** to highlight CLEAR MENU. Press **ENTER** and use the **UP/DOWN ARROWS** to highlight ERASE TRACK and press **ENTER**. You will be asked to confirm that you want to erase the track history. If you change your mind, press any other function key to leave the track as it is.



Viewing the ROAD Screen

Access the ROAD screen by pressing the **PLOT** key (two or three times, if necessary). This is the navigation CDI screen. As with the preceding screen, the bearing and distance to the leg destination are displayed.

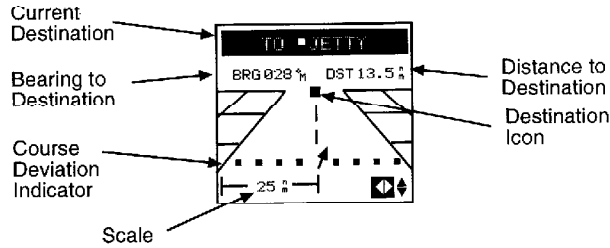

This screen depicts the course you should be on as the center line and your position relative to the course (the arrow icon). Any waypoints that would appear on or near this course line are displayed as they come into range.

When a route is active, you can adjust the CDI scale by pressing the **LEFT/RIGHT ARROWS** shown in the bottom left corner of the screen.

WAYPOINTS

Saving a Position Fix as a Waypoint

During normal operation your receiver continuously computes your position and displays that information on the *POSITION* screen. Quite often you will want to store the position data for use later on. This stored fix is referred to as a waypoint. An obvious use would be to store the position where you are now with a unique name. That way if you were to go to a new location you could use your receiver to guide you back to your current location.

Receiver Generated Waypoint Name



User Defined Waypoint Name



From any NAV or PLOT screen, press **ENTER**, highlight SAVE POS and press **ENTER**. This tells the receiver that you want to store the current position as a waypoint. The cursor is in the upper left corner of the display and the highlighted arrow icons indicate that it is in the edit mode. What you will do next is assign a name to this position.

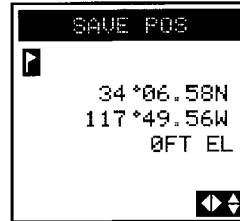

The waypoint name can be created by the receiver or you can input a name that means something to you. If you press ENTER without creating a name the receiver assigns a waypoint name. Waypoint names assigned by the receiver appear in the format Ψ WPxxx, where the xxx is a sequential number (001, 002, etc.).

To allow the receiver to name the waypoint, press **ENTER**. The following screen will appear briefly and then the receiver returns to the *POSITION* screen.

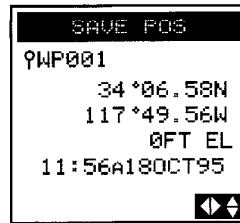

or

Use the **ARROWS** to assign a waypoint name that describes the position being saved. A waypoint name always starts with an identifier icon and 1 to 5 characters. After assigning a name, press **ENTER**. The following screen will appear briefly and then the receiver returns to the *POSITION* screen.

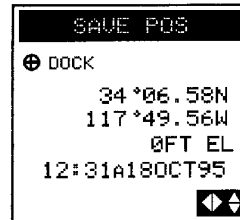

Available Icons:

- | | | |
|-------------------|---------------|-------------|
| Right flag (▶) | Left flag (◀) | Diamond (◆) |
| Double box (▣) | Anchor (⚓) | Square (■) |
| Diving symbol (▣) | Fish (♣) | Target (⊕) |

Creating a Waypoints

This allows you to create and store a waypoint with a receiver-generated name or a user-assigned name and allows you to assign the position coordinates.

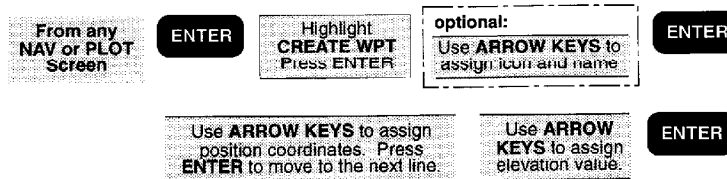

From any NAV or PLOT screen, press **ENTER**, highlight **CREATE WPT** and press **ENTER**. The *CREATE WPT* screen appears.

Press **ENTER** to accept a receiver-generated name or use the **ARROWS** to assign a name of your choice and press **ENTER**.

The cursor moves to the first line of the position. Use the **UP/DOWN ARROWS** to scroll through the number list, and use the **LEFT/RIGHT ARROWS** to move the cursor. If using LAT/LON coordinate system, the **UP/DOWN ARROW** toggles between N and S. Press **ENTER** to confirm and continue.

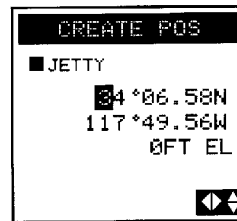

Using the **LEFT/RIGHT** and **UP/DOWN ARROWS** you can change the second line of the position. If using LAT/LON coordinate system, the **UP/DOWN ARROW** toggles between E and W. Press **ENTER** to save the changes.

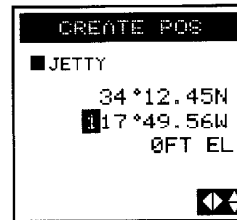

You may now assign the elevation. If you do not know the elevation, press **ENTER** to accept the displayed value. In a few seconds the new waypoint is saved and the receiver returns to the NAV screen from which you started.

Accessing the Waypoint Menu

The Waypoint Menu contains up to 200 named waypoints, displayed in two columns of four waypoints each and extending to several pages.



To access the Waypoint Menu, press **MENU**. Use the **UP/DOWN ARROWS** to select **WAYPOINTS** and press **ENTER**. This will take you to the *WPT MENU* screen. This is a listing of all the waypoints you have stored in your receiver.

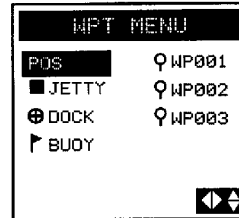

As the number of waypoints in the library increases, the *WPT MENU* screen will add a second column of four waypoint names to the right of the ones you have now, and will continue to another "page." Use the **LEFT/RIGHT ARROWS** move from column to column and the **UP/DOWN ARROWS** move up and down through the list. When you reach the end of the page, the cursor will automatically scroll to the next page.

Viewing a Waypoint



From the *WPT MENU*, use the **UP/DOWN** and **LEFT/RIGHT ARROWS** to highlight the waypoint you wish to view and press **ENTER** to display the *WAYPOINT* screen. This screen closely resembles the *POSITION* screen with the notable addition of the time and date the waypoint was saved.

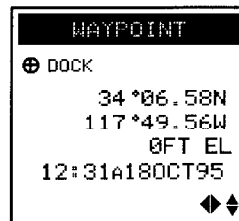

Use the **LEFT** or **RIGHT ARROWS** to display the *WAYPOINT* screen for adjacent waypoints in the waypoint list. Continue pressing the **LEFT** or **RIGHT ARROW** to scroll through the entire list.

The **UP/DOWN ARROWS** give the bearing (BRG) and distance (DST) for the selected waypoint on the *POINTER* screen.

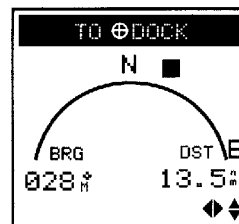

Accessing the Waypoint Function Menu



Press **MENU**, use the **UP/DOWN ARROWS** to select **WAYPOINTS** and press **ENTER**. Select a waypoint from the list and press **ENTER** to access the **WAYPOINT** screen, press **ENTER** again to access a menu of functions that may be performed on the selected waypoint.



The **ESCAPE** option, highlighted at the top of the menu, allows you return to the **WAYPOINT** screen by pressing **ENTER** when **ESCAPE** is highlighted.

Projecting a Waypoint

This function allows you to project a waypoint, which means to create a waypoint at a certain distance and bearing from an existing waypoint.

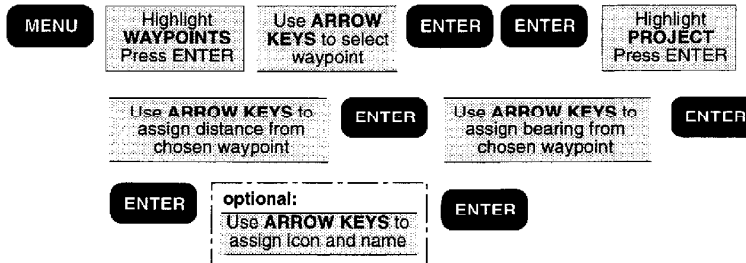

Press **MENU**, use the **UP/DOWN ARROWS** to select **WAYPOINTS** and press **ENTER**. Select the waypoint in the list from which you wish to project a new waypoint, then press **ENTER** to access the **WAYPOINT** screen. Now press **ENTER** to access the function menu, highlight **PROJECT** and press **ENTER**.

The **WPT PROJECT** screen appears with the cursor positioned on the first character in the distance field (**DIST**).

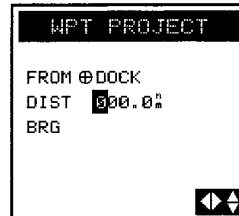

Use the **UP/DOWN** and **LEFT/RIGHT ARROWS** to key in the distance at which you wish to project the new waypoint. When you have finished, press **ENTER** to confirm and continue.

The cursor appears in the bearing field (BRG). Use the **UP/DOWN** and **LEFT/RIGHT ARROWS** to key in the bearing at which you wish to project the new waypoint. When you have finished, press **ENTER** to confirm.

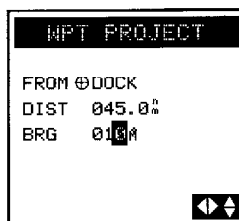

The coordinates of the projected waypoint you have just created appear on the *WPT PROJECT* screen.

To save these coordinates as a waypoint, press **ENTER** to access the *DEFINE WPT* screen, assign a name using the **UP/DOWN** and **LEFT/RIGHT ARROWS**, then press **ENTER**.

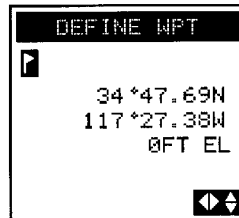

The projected waypoint is saved as a new waypoint and the display returns to the *WAYPOINT* screen from which you projected the new waypoint.

Editing a Waypoint

This enables you to rename a waypoint (optional) and to change the coordinate values for the waypoint.

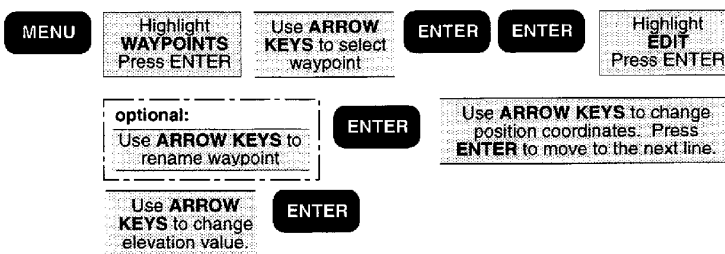

Press **MENU**, use the **UP/DOWN ARROWS** to select **WAYPOINTS** and press **ENTER**. Select a waypoint from the list and press **ENTER** to access the *WAYPOINT* screen. Press **ENTER** to access the function menu, highlight **EDIT** and press **ENTER**.

Changing the name of the waypoint is the first option. Use the **LEFT/RIGHT ARROWS** to move the cursor and the **UP/DOWN ARROW** to select the characters. After changing the waypoint name or if there are no changes to the waypoint name, press **ENTER**.

Make a changes to the position using the **UP/DOWN ARROWS** to scroll through the number list, and use the **LEFT/RIGHT ARROWS** to move left and right. Press **ENTER** to accept the changes. After all changes are made to the position and elevation, press **ENTER**. In a few seconds the changes will be saved and the receiver returns you to the *WAYPOINT* screen of the edited waypoint. Any name changes that you made under edit have been saved, replacing the former name and/or coordinates.

 If you edit a waypoint contained in a route, the selected waypoint will be copied, with changes, as a new waypoint. The route and the original waypoint you selected will remain unchanged.

Deleting a Waypoint

Used to permanently remove a waypoint from your receiver's memory.

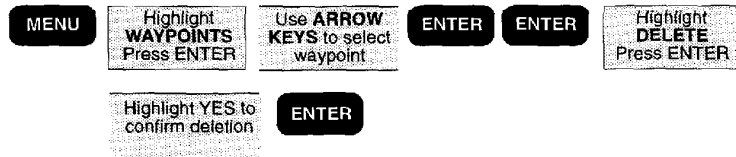

Press **MENU**, use the **UP/DOWN ARROWS** to select *WAYPOINTS* and press **ENTER**. Select the waypoint in the list you wish to delete, then press **ENTER** to access the *WAYPOINT* screen. Now press **ENTER** to access the function menu, highlight *DELETE* and press **ENTER**.

The receiver will now give you one last chance to change your mind. If you are sure, use the **UP/DOWN ARROWS** to highlight *YES* and press **ENTER**. The waypoint is now erased and you are returned to the next waypoint in the list.

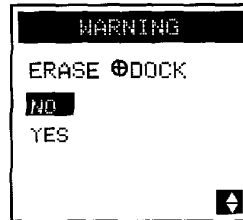

 Waypoints that are currently used in a route (discussed in the next section) cannot be cleared. The receiver will warn you if you attempt to do so.

ROUTES

A route is a planned course of travel defined by a series of waypoints. To create a route, you must already have waypoints stored in the receiver's memory. These waypoints are then connected to form the segments or "legs" of the route. A route may contain from one to fifteen legs.

Activating a GOTO Route

The GOTO function enables you to create a simple one-leg route from your present position to a defined waypoint. When a GOTO is active, the title bar of the NAV and PLOT screens display "TO Destination Waypoint" and the screens display the corresponding navigation information.

GOTO

Use **ARROW KEYS**
to select
destination waypoint

ENTER

Press **MOB/GOTO**, use the **UP/DOWN ARROWS** to highlight the desired destination waypoint, and press **ENTER**.



The first four selections in the GOTO menu allow you to create a Man OverBoard, Backtrack or Coordinate route or to activate an existing route. MOB, BCKTRK and COORD functions are discussed at the end of the Route section.

It is also possible to activate a GOTO from the PAN N SCAN feature on the PLOT screen as described earlier.

The receiver begins navigating toward the selected waypoint and the display returns to the last viewed NAV screen.

It is necessary to have a current position fix in order to correctly activate a GOTO. If you have a current position fix, the NAV screens will display navigation data, if not, the navigation data will be replaced by dashes.



If a route, GOTO, or MOB is already active, the new GOTO automatically replaces it and becomes the active route.



A GOTO always uses your current position as the starting point. If the unit has not yet computed a position fix, then the start of the GOTO may not represent your current position.

Accessing the Route Menu

The Route Menu is used to create and view up to five single or multi-leg routes. A pop-up menu allows you to activate, deactivate, or reverse a selected route, edit or view the legs of the route, or clear the route.

The ROUTE MENU can be accessed in three ways:

- 1 Press **MENU**, use the **UP/DOWN ARROWS** to select ROUTE MENU in the FUNCTION MENU, and press **ENTER**.



- 2 From any NAV or PLOT screen, press **ENTER** to access the pop-up menu, select ROUTE MENU and press **ENTER**.



- 3 Press **GOTO** and highlight ROUTE and press **ENTER**.



Creating a Multileg Route

This creates a route of 1 to 15 legs. Each leg has a start and end waypoint. Each end waypoint is the start waypoint for the following leg.



To finish creating a multileg route, press ENTER without selecting a "10" waypoint.

Access the ROUTE MENU. Use the **UP/DOWN ARROWS** to select an EMPTY route and press **ENTER**.



If there are no EMPTY routes in the ROUTE MENU, you must clear a route before you can create a new one.

Use the **LEFT/RIGHT ARROWS** to select the FROM waypoint and press **ENTER**. This is the starting position for this leg of your route. The default waypoint in the FROM field is the current position, labeled as \varnothing STRT1. The "1" indicates that it is the START waypoint of Route 1.



The highlight moves down to the TO line. Use the **LEFT/RIGHT ARROWS** to change the TO waypoint to be the destination for this leg. Note that the screen displays the bearing and distance for this leg of the route. Press **ENTER** to confirm the TO waypoint.



The receiver automatically used the TO waypoint from the previous leg as the FROM waypoint for the next leg.



Continue to add legs to this route by using the **LEFT/RIGHT ARROWS** changing the TO waypoint and **ENTER** to confirm. The bearing and distance are updated as you scroll through the various TO waypoints.

When you have created as many legs of the route as desired, simply press **ENTER** with the TO highlight blank.

The display returns to the Route Menu. The new route is now the active route, and can be viewed on the NAV and PLOT screens.



The receiver will not accept TO waypoints having the same or nearly the same coordinates (within 0.1 nm) as the FROM waypoint.

Activating and Deactivating a Route

Only one route, MOB, BACKTRACK, COORD route or GOTO can be active (in use) at any time. When you set a MOB, GOTO or BACKTRACK route, any multileg route that you were using is automatically deactivated and replaced with the route you just set. Likewise, creating a multileg route makes that route the current active route, deactivating any other route.

Access the
**ROUTE
MENU**

Use **ARROW KEYS**
to highlight route to
activate / deactivate

ENTER

ENTER

Access the **ROUTE MENU** and use the **UP/DOWN ARROWS** to highlight the route you wish to activate or deactivate and press **ENTER** to display the pop-up menu.

Use the **UP/DOWN ARROWS** to highlight **ACTIVATE** or **DEACTIVATE** and press **ENTER**.

If the route you selected is currently active, **DEACTIVATE** will appear on the menu, and pressing **ENTER** will deactivate the route. If the route is not active, **ACTIVATE** will appear on the menu, and pressing **ENTER** will activate the route and return you to the last viewed NAV screen.

Reversing a Route

REVERSE ROUTE allows you to take an existing route and reverse the order of waypoints in the route. For example, if you were to set a route that went from point A to point B and ended at point C, **REVERSE ROUTE** would change the route to go from point C to point B and ending at point A.

Access the
**ROUTE
MENU**

Use **ARROW KEYS**
to highlight route to
be reversed

ENTER

Highlight
REVERSE
Press **ENTER**

Access the **ROUTE MENU**, highlight the route you want to reverse, and press **ENTER**. Use the **UP/DOWN ARROWS** to highlight **REVERSE** and press **ENTER**.

The route is reversed and the display returns to the **ROUTE MENU**.

Viewing the Route Summary (Edit Option)

The edit option displays a summary of the selected route, including starting and ending waypoints, number of legs, and total distance. It allows you to view, insert, delete and replace individual legs of a route, as well as choose the leg on which you want to navigate by making this the current active leg.

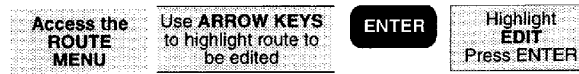

Access the ROUTE MENU. Use the **UP/DOWN ARROWS** to highlight the route you want to view and press **ENTER**. Use the **UP/DOWN ARROWS** to highlight EDIT and press **ENTER**.

The *SUMMARY* screen for the selected route is displayed.

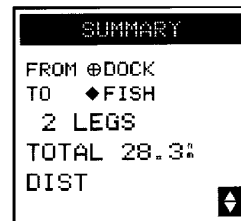

Viewing the Legs of a Route

This allows the legs of a route to be viewed. It is also the entry point from which legs can be added, removed, or replaced.



To review the route by viewing each of the legs individually, starting from the *SUMMARY* screen, press the **UP/DOWN ARROWS** stepping through each leg of the route and back to the route summary.



Inserting a Leg in a Route

You can insert a leg in a route by inserting a waypoint between the starting and ending waypoints of an existing leg, thereby dividing it into two legs.

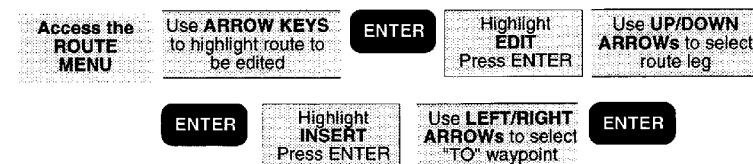

Access the ROUTE MENU and highlight the route to insert a leg into. Press **ENTER** to bring up the pop-up menu, highlight EDIT, and press **ENTER**. Use the **UP/DOWN ARROWS** to view the route leg in which you want to insert a waypoint, press **ENTER** to access the EDIT LEG menu, select INSERT, and press **ENTER**.

A highlight bar appears for you to select the new TO waypoint for this leg, thereby creating a new waypoint and "pushing" the other waypoints in the route forward to make room.



Use the **LEFT/RIGHT ARROWS** to scroll through the waypoint list to the waypoint you wish to use as the destination for this new intermediate leg and press **ENTER**.

The new leg has now been added. The FROM waypoint did not change but the TO waypoint is now the one you just entered. The receiver has updated the bearing and distance for this leg and displays it on the screen.

Press the **DOWN ARROW**. The following leg has also been changed. The following leg now starts from the waypoint you designated as the TO waypoint for the previous leg.

 The new TO waypoint must be different from the old (must have a distance greater than 0.1 distance units from the "FROM" waypoint); the receiver will not insert a leg in this case but will return to the leg screen you were viewing.

Deleting a Leg

Another feature of editing a route is the ability to delete one of the legs.



Access the ROUTE MENU and highlight the route to be edited. Press **ENTER**, highlight EDIT, and press **ENTER**. Use the **UP/DOWN ARROWS** to view the route leg to be deleted, press **ENTER** to access the EDIT LEG menu, select DELETE, and press **ENTER**.

The receiver gives you one last chance to change your mind. Press **ENTER** to confirm. The leg is removed from the route. Press any function key to abort the process.

Adding a Leg

You can add a leg to the end of the route in much the same way as you would insert a leg, only this time you add a waypoint to extend the end of the route beyond the original destination.



Access the ROUTE MENU and highlight the route to be edited. Press **ENTER** to bring up the pop-up menu, highlight EDIT, and press **ENTER**. Use the **UP/DOWN ARROWS** to view the last leg in the route. Press **ENTER** to access the EDIT LEG menu, select ADD LEG, and press **ENTER**.



If ADD LEG does not appear as an option of the Leg Edit menu, you were not viewing the final leg of the route. To add a leg to the end of a route, you must be viewing the final leg when you access the Leg Edit menu. (To add a leg *within* a route, see Inserting a Leg in a Route.)

The *ADD LEG* screen appears with the destination waypoint of the route in the FROM field. It is used as the starting point of the final leg you wish to create. A highlight bar appears for you to select the new TO waypoint for this leg.

Use the **LEFT/RIGHT ARROWS** to scroll through the waypoint list to the waypoint you wish to use as the destination for this new final leg and press **ENTER**.

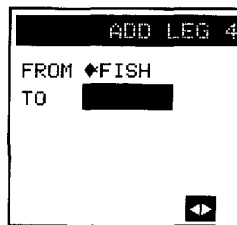

The new leg has now been added. The receiver displays the bearing and distance for this new final leg.

Replacing a Waypoint

This allows the destination (TO) waypoint of a leg to be changed to a different waypoint.

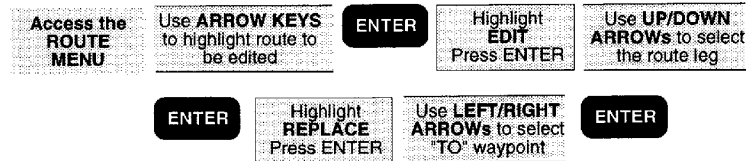

Access the ROUTE MENU and highlight the route to be edited. Press **ENTER** to bring up the pop-up menu, highlight EDIT, and press **ENTER**. Use the **UP/DOWN ARROWS** to view the leg to be modified. Press **ENTER** to access the EDIT LEG menu, select REPLACE, and press **ENTER**.

A highlight bar appears for you to select the new TO waypoint for this leg, replacing the existing one.

Use the **LEFT/RIGHT ARROWS** to scroll to the waypoint you wish to use as the new destination for this leg of the route and press **ENTER**.

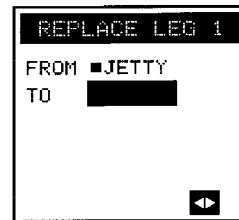

The new TO waypoint must be different from the old (must have a distance greater than 0.1 distance units from the "FROM" waypoint)); the receiver will not insert a leg in this case but will return to the leg screen you were viewing.

The destination has now been changed. The receiver has updated the bearing and distance for this leg and displays it on the screen.

Press the **DOWN ARROW**. The following leg has also been changed. The following leg now starts from the waypoint you designated as the TO waypoint for the previous leg.

Navigating (Activating) a Leg

While navigating using a multileg route, one leg of the route is said to be active. This is the leg that is currently being used to provide navigational information. It is sometimes desirable to activate a different leg, thereby changing the destination being navigated to.

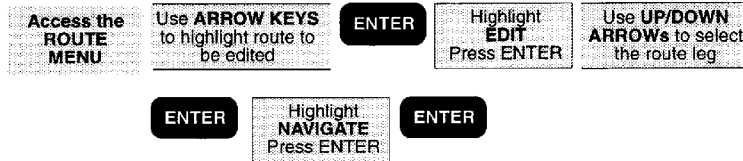

Access the ROUTE MENU and highlight the route to be edited. Press **ENTER** to bring up the pop-up menu, highlight EDIT, and press **ENTER**. Use the **UP/DOWN ARROWS** to view the leg to be activated. Press **ENTER** to access the EDIT LEG menu, select NAVIGATE, and press **ENTER**.

Press **NAV** or **PLOT**. The receiver begins navigating on the selected leg.

 If a route, GOTO, or MOB is already active, the leg you choose to navigate automatically replaces it as the active leg.

Clearing a Route

This operation permanently removes a route from the Route Menu returning the route to the "EMPTY" status.



Access the ROUTE MENU and highlight the route to be cleared. Press **ENTER** to bring up the pop-up menu, highlight CLEAR, and press **ENTER**. Use the **UP/DOWN ARROWS** to confirm (YES) or abort (NO) clearing the route. Press **ENTER**. The route has now been cleared from memory.

Creating a MOB (Man OverBoard) Route

The MOB, or Man OverBoard function causes the receiver to save the position that is current when the feature is accessed and to create a one-leg route back to that position.



Press **MOB**. Highlight MOB and press **ENTER**.

 If you have already saved an MOB position, the receiver gives you the option of creating a new MOB position by displaying a confirmation screen. To select a new MOB, press the **DOWN ARROW** and **ENTER**.



The MOB position and MOB route information will be lost when the receiver is turned off.

Creating a Backtrack Route

This creates a route using fixes in the Last Fix Buffer (up to 16 of the most recent last fixes) to create a route that “backtracks” the course you last took. This way you could leave point A, travel for a couple of hours, set a backtrack route, and the receiver would guide you back to point A following the same course you just took.

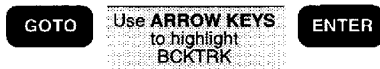

Press **GOTO**, **DOWN ARROW** to highlight BCKTRK, and press **ENTER**. A backtrack is created in the first available route.

The display returns to the last viewed NAV screen and shows navigation information for the destination waypoint of the first leg of the BACKTRACK route.



If all five routes are full a message screen appears indicating that a route must be cleared in order to create a backtrack. (If this is the case, see Clearing a Route.)

Backtrack waypoints use an up arrow (^) icon to indicate that they were created in backtrack. How many of these waypoints were created (up to 16) is determined by the number of fixes in your last fix buffer.

Creating a COORD Route

The COORD option allows you to create a one-leg route to a position *not* contained in the waypoint list, simply by providing its coordinates.



Press **GOTO**, use the **UP/DOWN ARROWS** to highlight COORD and press **ENTER**.

The COORD screen appears. The cursor is on the leftmost character of the latitude field and the arrow icons indicate that the display is in edit mode. The position shown is the last position fix taken.

Edit the coordinates using the **UP/DOWN ARROWS** to scroll through and select numbers, and the **LEFT/RIGHT ARROWS** to move the cursor. At the rightmost position, the UP/DOWN ARROWS toggle between N/S and E/W if using LAT/LON coordinate system.

The receiver immediately begins navigating toward the selected coordinates. The display returns to the last viewed NAV screen and the words TO COORD appear in the title bar.

 The COORD position and COORD route information will be lost when the receiver is turned off.

Last Fix Buffer

While you are taking position fixes your receiver can automatically save them. The receiver will store position fixes in the last fix buffer at a rate you defined in SETUP under LAST FIX INTERVAL.

Viewing a LAST FIX

MENU Highlight **LAST FIXES** Press **ENTER** Use **LEFT/RIGHT ARROW** keys to select last fix

Press **MENU** and use the **UP/DOWN ARROWS** to highlight LAST FIXES (on the second page of the Function Menu) and press **ENTER**. The *LAST FIX* screen that appears exactly duplicates the screen you have already seen when viewing a waypoint.

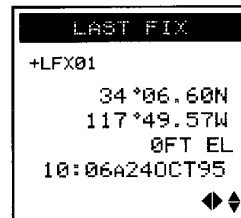

Notice that the receiver has assigned a name that begins with a plus (+) and is followed by a two-digit number. This number will increase as the Last Fixes are being taken with the higher the number, the older the fix. The receiver will store a total of 16 Last Fixes.

Use the **LEFT/RIGHT ARROWS** to scroll through the other last fixes in the buffer.

Viewing the LAST FIX Trip Summary Screen

This screen informs you that the summary you are about to view will cover the trip you made from the time the selected last fix was recorded to your present position (POS) or a different last fix.

MENU Highlight **LAST FIXES** Press **ENTER** Use **LEFT/RIGHT ARROW** keys to select any last fix except +LFX01 
Use **LEFT/RIGHT ARROW** keys to select "TO" last fix or POS **ENTER**

Press **MENU** and use the **UP/DOWN ARROWS** to highlight LAST FIXES and press **ENTER**. Use the **LEFT/RIGHT ARROWS** to select any Last Fix except +LFX01. Press the **UP ARROW**. Use the **LEFT/RIGHT ARROWS** to select any of the other fixes present in the last fix buffer that were taken after the one chosen as the "FROM" waypoint.

```

TRIP SUMMARY
FROM  +LFX16
      07:46A240CT95
TO    POS
      10:14A240CT95
      
```

Press **ENTER** for the Trip Summary.

```

TRIP SUMMARY
+LFX16 POS
ODOM  0.91
TIME  2:28HR
MAX VEL 6.0KTS
MIN VEL 0.0KTS
AUG VEL 0.4KTS
      
```

 If you select +LFX01 as the FROM waypoint you will not be given the opportunity to change the "TO" waypoint since there have been no other fixes saved since +LFX01 was recorded. A message "SELECT OLDER STARTING FIX FOR TRIP" appears.

SETUP OPTIONS

Setup options allow you to customize your receiver to display information in the format that best suits your needs.

Initializing the Receiver

This option was discussed in more detail earlier, but, in general, INITIALIZE allows you to input the approximate coordinates, time, and date for your present position if the receiver has computed a position fix or if it has had its memory cleared. This function should also be used any time the unit is moved more than 300 miles with the unit turned off, to help the receiver acquire a fix faster.

MENU Highlight **SETUP** Highlight **INITIALIZE** Use **ARROW KEYS**
 Press **ENTER** Press **ENTER** to enter coordinate information

Setting the Coordinate System

The coordinate system you ultimately select will depend on the maps or charts that you are using with your receiver. The default coordinate system is LAT/LON, DEG/MIN.00.



If you select LAT/LON, you will be asked to select one of three formats for displaying position coordinates: DEG/MIN.00, DEG/MIN.000 or DEG/MIN/SEC. If you choose one of the first two options, the display is in *decimal* format, while the third option is based on 60 seconds in a minute.

Available Coordinate Systems:

UTM	LAT/LON	OSGB
TD	IRISH GRID	SWEDISH GRID
	SWISS GRID	

Setting the Elevation Mode



In addition to position, your receiver can compute your elevation when it is receiving signals from at least four satellites. This is referred to as "3D" Elevation Mode.

When there are only three satellites in view, the receiver cannot compute elevation though it can still compute your position. In this case the receiver will display the last computed elevation or the elevation that you manually enter in INITIALIZE. This elevation mode is referred to as "2D" (the default setting). You may select either elevation mode in this SETUP feature.

If you select the 2D elevation mode you will be prompted to input the elevation. If you are unsure of the elevation you can press ENTER to accept the previously used elevation.

If you select the 3D elevation mode, the receiver will calculate elevation whenever signals are being received from at least four satellites. When fewer satellites are being tracked, the receiver will default to 2D and display the 2D icon.

Selecting Time Display

Your Magellan receiver can display time in one of three formats: local 24-hour (military), local 12-hour (AM/PM), or UT (Universal Time or Zulu). The default Time Display is LOCAL AM/PM.

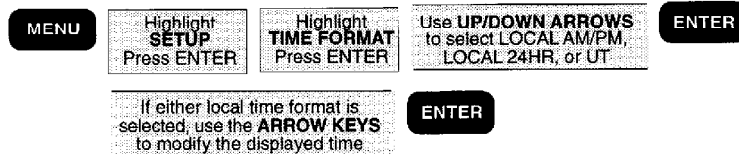

 If the receiver does not have a computed position fix the receiver displays a warning to alert you that an initial time has not been set in INITIALIZE. After inputting an initial time you may change the format that time is displayed in.

Setting Velocity Averaging

As you are travelling with your receiver on you may notice fluctuations in the velocity displayed. Like elevation, velocity is very susceptible to Selective Availability. Velocity Averaging will minimize this effect by displaying an averaged speed measurement. You have three options to choose from: OFF (no averaging) would be used where you require rapid updates of velocity: 20 SECONDS would be selected where rapid updates of velocity are not essential, generally at fairly low velocities; or 60 SECONDS where immediate velocity information is relatively unimportant, such as a long journey at a constant speed. The default is OFF.



Setting Speed Units

SPEED UNITS allows you to select the unit of measure for speed measurements. You may choose from KNOTS, MPH or KPH. The default is KNOTS.



Setting Distance Units

DIST. UNITS (Distance Units) allows you to select the unit of measure that distances will be displayed in. You may choose from NM (nautical miles), ST.MILES (statute miles), or KM (kilometers). NM is the default setting.



Setting Elevation Units

ELEV. UNITS (Elevation Units) is the same as DIST. UNIT but this time you will select the unit of measure that will be used to display your elevation in, METERS or FEET. The default setting is FEET.



Setting North Reference.

This sets the north reference of the displays to TRUE or MAGNETIC. The default North reference is MAGNETIC.



Selecting Map Datum

Depending upon which map or chart you are using you may need to change the Map Datum that the receiver will use. The datum required will be printed on the map or chart. The most common is WGS84, which is also the default Map Datum.



Setting NMEA

NMEA is the communication standard for electronic marine navigation equipment. Your receiver outputs position and navigation information in the NMEA 0183 format to support navigation aids such as autopilots. To use NMEA your receiver must be connected to the NMEA device with the Power/Data Cable and the device you're using must accept the proper 0183 format. Your GPS receiver must be on and computing fixes **before** NMEA information will be output through the data port.





The Power/Data Cable is included with the NAV 1200XL. An optional Power/Data Cable is available for the Meridian XL from your local dealer or directly from Magellan Systems.



[Meridian XL] Keep in mind that in order to support the NMEA device, your receiver must be operating continuously. To prevent outages due to low batteries, external power is recommended.

Selecting Baud Rate.

BAUD RATE allows you to select the appropriate baud rate for your external equipment. (Check the documentation of your external equipment.) You may choose from 1200, 4800, 9600 or 19200. The default setting is 4800.



Selecting Waypoint Sort

WPT SORT allows you to classify the waypoints stored in the user waypoint catalog in alphabetical order or according to their proximity to the present position with the closest listed first. You may choose from ALPHABETICAL or NEAREST. The default setting is ALPHABETICAL.



Selecting the Last Fix Interval

This function allows you to set the rate that positions are automatically saved to the last fix buffer. The default is 10 minutes.



Plot Setup

PLOT SETUP allows you to adjust the track orientation and track history on the PLOT screen.

For TRACK you may select OFF, 0.1, 0.5, 1.0, or 5.0. The default setting is 1.0. For ORIENTATION, you may select HEADING UP or NORTH UP. The default setting is HEADING UP.



Setting Alarms

Your Magellan receiver has the ability to sound an external alarm when you arrive at your destination (ARRIVAL); have moved a predefined distance from the place where you set your anchor (ANCHOR); and/or if your cross track error is greater than the defined radius (XTE).

With the alarm menu displayed, you can turn an alarm on or off by pressing the **ENTER** key.

If you turn on the ANCHOR, XTE or arrival alarms, you will have the option of changing the radius of the selected alarm. The default is set at 500 feet. If an alarm is turned on it will be preceded by a ✓ (check mark). Use the **LEFT/RIGHT ARROWS** to turn alarms on and off.

Press **ENTER**, and use the **UP/DOWN** and **LEFT/RIGHT ARROWS** to set radius of a selected alarm. To exit the ALARM MENU, highlight ESCAPE and press **ENTER**.

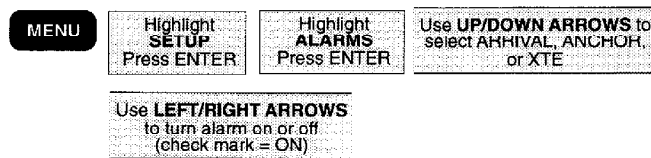

To Set Alarm Radius:



To Exit Alarm Menu:

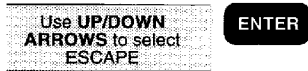

Sampling

Sampling causes the receiver to turn itself on every 10 minutes, 20 minutes, 30 minutes, or 1 hour, compute a position fix, store the fix in the last fix buffer, and then turn itself off.





In order to use Sampling, the receiver's antenna must remain in an open area and fully visible to the sky. If the antenna is blocked so that the receiver cannot acquire sufficient satellites the receiver will be unable to compute a position fix and the receiver will remain on until the obstruction is removed.

When Sampling is on, a warning message appears on the *POWER DOWN* screen to remind you that you have Sampling on.

Sampling will continue until it is turned off or until the battery warning is displayed.

When the unit is turned on again, a message will appear requiring you to confirm whether you want SAMPLING on or off. Select ON or OFF using the **UP/DOWN ARROWS** and press **ENTER**.

Light Intensity

LIGHT INTEN. allows you to select the brightness level (HIGH or LOW) of the display. The light can be switched on and off by holding down the "LIGHT" key.



Contrast

CONTRAST allows you to adjust the contrast level of the display to allow you to select the best contrast level for the particular environment you are in.

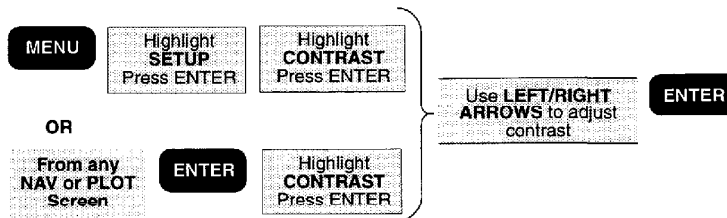

Additional Features

Viewing the SAT STATUS Screen

This screen displays the satellites by their signal strength and their position in the sky relative to your location. An asterisk (*) indicates that the unit is not locked on to that particular satellite. When lock is achieved the * will be replaced by the signal strength of the satellite. Signal strength will range from 0 to 9, with 9 representing better signal strength.



Press **MENU**, highlight SAT STATUS and press **ENTER**. The receiver displays the SAT STATUS screen.

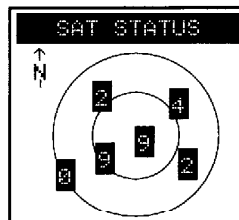

Viewing the Odometer

The Odometer feature displays the ODOMETER screen which keeps track of total distance traveled as well as trip distance, similar to the odometer in an automobile.



Press **MENU**, highlight ODOMETER on the second page of the function menu and press **ENTER**.

The ODOMETER screen appears, showing the total distance traveled and the distance traveled on the current trip.

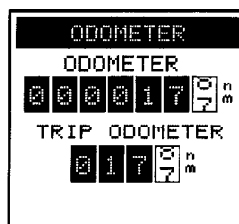

Resetting the Odometer and/or Trip Odometer



Highlight ESCAPE and press **ENTER** to return to the Odometer Screen. Press any function key or the Menu key to exit the Odometer Screen.

Viewing the Clock

The Clock option will display the current date and time in the time format selected during setup.



Press ENTER to return to the Function Menu.

Viewing the SUN/MOON Screen

This screen will display the time of sunrise and sunset for the chosen waypoint. It also graphically displays the lunar cycle of the moon.

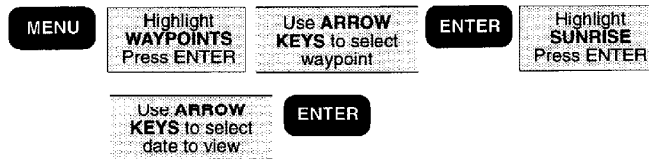

Press **MENU**, use the **UP/DOWN ARROWS** to select **WAYPOINTS** and press **ENTER**. Select the waypoint in the list for which you wish to view sunrise information, then press **ENTER** to access the **WAYPOINT** screen. Now press **ENTER** to access the function menu, highlight **SUNRISE** and press **ENTER**.

The first step in viewing the solar and lunar information is to enter the date for which you want the information. Use the **UP/DOWN and LEFT/RIGHT ARROWS** to set the date and press **ENTER**.



The receiver will compute the sunrise, sunset, and lunar cycle for the waypoint chosen on the date you entered.

-  Full moon
-  Half moon
-  New moon

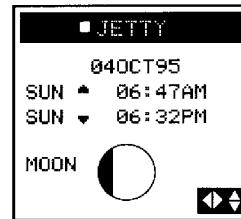

Simulator

The simulator mode causes the receiver to create a fictitious route from your location to two newly created waypoints. You will find the Simulator very handy when you want to review or practice using your receiver at home. In the simulate mode you can watch the receiver simulate movement and observe how the different navigational screens respond.



To activate, press **MENU** and use the **UP/DOWN ARROWS** to select **SIMULATOR**, then press **ENTER**. You will then be prompted to press **NAV** to return to the NAV Screen. After using the Simulator, be sure to turn it off again by highlighting **SIMULATOR** function under the **MENU** key and pressing **ENTER**. If you turn the receiver off before you turn the simulator off, the waypoints and route it created will not be cleared.

Erasing Last Fixes

ERASE LFIX will erase all of the waypoints in your Last Fix Buffer.

Press **MENU** and highlight the **CLEAR MENU**. Press **ENTER** and use



the **UP/DOWN ARROWS** to highlight **ERASE FIX**. You will be instructed to press **ENTER** to erase the Last Fixes. If you change your mind, press any other function key to leave the last fixes as they are.

Erasing Track from the Plotter Screen

As you use your receiver more you may soon notice the **PLOT** screen becoming cluttered with the graphic display of your past movement (track). You can erase the track display with the **ERASE TRACK** option.

Use the **UP/DOWN ARROWS** to highlight **ERASE TRACK** and press



ENTER. You will be asked to press **ENTER** to confirm that you want to erase the track history. If you change your mind, press any other function key to leave the track as it is.

Erase All Waypoints from Waypoint List

ERASE WPTS will erase all of the waypoints in your waypoint list. If routes currently exist, clearing waypoints requires that all routes be cleared and a message will be displayed. See *Clearing Routes*.



Highlight ERASE WPTS using the **UP/DOWN ARROWS** and press **ENTER**. You will be instructed to press **ENTER** to erase the waypoints. If you change your mind, press any other function key to leave the waypoints intact.

Clearing Receiver Memory



This reset will erase all of the waypoints in your receiver's memory. Before selecting **Clear Menu** we recommend that you review the waypoints in your waypoint library, recording on paper the coordinates for any waypoint that you want to use in the future. After turning the receiver back on, you can enter those waypoints again.

Clear Memory will erase all of your receiver's memory including resetting all of the Setup features to their default values.



Press keys as instructed by receiver

To access Clear Memory, use the **UP/DOWN ARROWS** to highlight CLEAR MEMORY and press **ENTER**. You will then be given instructions as to which keys to simultaneously hold down to reset your receiver. If you change your mind, simply press any function key to escape.



Note that it is not required that you go to the SETUP menu to do a reset; holding down the proper keys at any time will reset your receiver.





[Meridian XL]. The keys to press simultaneously are NAV, MOB/GOTO, LIGHT, and MENU.





[NAV 1200XL] The keys to press simultaneously are GOTO and the UP ARROW.

Status Line Icons

Status appear on most screens and provide you with some valuable information as to the status of the position fixes that are being computed.

Most information on this line will be represented by icons which appear before the arrows on the right side of the status line. These arrows have two functions, depending on how they are displayed.

-  Inverted arrow icons in the lower right corner indicate that the ARROW keys are used to enter or edit information.
-  Non-inverted arrow icons indicate that there are other screens accessible from this screen using the ARROW keys.
-  *Poor Geometric Quality.* Appears when the Geometric Quality (GQ) of a position fix is below a set value and the accuracy of the position fix is questionable. Position information displayed may not be accurate enough to be used for navigation.
-  *Old Data.* The Old Data icon ("hourglass") appears when the receiver has been unable to update the position fix. The position information displayed is that of the last position fix computed.

Position and navigation information displayed while the Poor Geometric Quality and Old Data icons are being displayed may be inaccurate and should not be used for navigation.
-  *Low Signal Quality.* Is displayed if the Signal Quality (SQ) of one or more satellites used to compute a position fix drops below a minimum level. This has a minimal effect on accuracy, and is intended only to alert you that a signal may soon be lost.
-  *Two Dimensional.* The 2D icon indicates that the receiver is not receiving signals from at least four satellites to compute elevation information. The 2D icon is also displayed when you have selected 2D in the ELEV. MODE portion of Setup.
-  *Light On.* Indicates that the display light is on.
-  *Simulator.* Indicates that the simulator function is activated.
-  *Differential.* Indicates that the unit is receiving differential information.
- LOW BAT [Meridian XL] Battery Warning.** This alert will replace the number of satellites on the status line. It is warning you that you need to replace the batteries very soon or risk losing stored data.

Troubleshooting

frozen display, keypad does not respond

Remove power and wait for the receiver to turn off. If using a Meridian XL, remove and reinsert batteries. Turn power back on and press ENTER.

OR

[Meridian XL] Use the four-finger reset NAV, MOB/GOTO, LIGHT and MENU pressed together).

[NAV 1200XL] Use the two-finger reset (UP ARROW and GOTO pressed together).



The reset will clear the receiver's memory.

no power

[Meridian XL] Check how the batteries were inserted into the tray; are they oriented correctly? The batteries may also have run down completely.

[NAV 1200XL & Meridian XL] If operating from external power, the receiver may not have been hooked up correctly, or the external power source is not operating. Check the connections, and be sure the external power source is operating correctly.



Use only the Magellan Power/Data Cable to connect the receiver to external power.

position fix doesn't change

If the old data icon (⌘) is displayed, the signal from one or more satellites has been lost, and the receiver has been unable to reacquire or replace it. The displayed fix is at least 10 seconds old, and should not be used for navigation.

If there is no old data icon, the display may be frozen. Press any key to change the display. If the display does not change, refer to "frozen display."

position fix fluctuates

Small changes in the position coordinates and elevation are normal. They are caused by several variables, including the geometric quality of the fix and the effects of SA. Geometric quality is a measurement of the probable accuracy of a fix based on the position of the satellites being used in relation to each other.



NMEA device is not responding

The receiver may be outputting an NMEA data message that is not compatible with the NMEA device; check the message format selected with SETUP. Also check the connection between the receiver and the device, and be sure the device is on. *If supporting an autopilot, be sure that a route has been set and activated.*

How to Contact Customer Service

The list above should allow you to solve most of the operating problems you are likely to encounter. Simply disconnecting the unit from power for a moment may solve your problem. If this does not help, try clearing the receiver's memory in the Setup Menu and reinitializing your receiver.

If you are unable to solve your operation problems, please call Magellan's Customer Service at 909-394-5000. Representatives are available Monday through Friday, from 8 A.M. to 5 P.M., Pacific Standard Time. Faxes can be sent to Customer Service at 909-394-7050.

If necessary, you can also return your unit to Magellan for repair. (Please call for assistance first.) If possible, please notify us before shipping the unit by Parcel Post or UPS, and include with the unit a description of the problem and your name and address. If your return shipping address is different, please include it.

With all correspondence, please be sure to state the model of the receiver you have and if calling, please be sure to have your unit with you.

Packages should be sent to:

Magellan Systems Corporation
960 Overland Court
San Dimas, CA 91773
Attn.: Warranty/Repair



Appendix

Optional Accessories

In addition to the items provided with the receiver, optional accessories are also available.

Mounting Kit [Meridian XL]. Includes a mountable bracket for hands-free operation, a 10–16 VDC Power/Data Cable, the Antenna Extension Cable, and the Antenna Suction Cup Mount. The Extension Cable and Suction Cup Mount are required to operate with the quadrifilar antenna detached. Do not alter the length of the antenna extension cable or use a non-Magellan cable, as this may adversely affect receiver sensitivity.

External Antenna [Meridian XL]. An external antenna that is mounted to a range pole or vehicle roof in order to provide satellite signals to the receiver when being operated in a sheltered location. Does not require a separate power source. Comes with 30 feet of connecting cabling and mounting hardware.

Magnetic Mount for External Antenna [Meridian XL and NAV 1200XL]. A magnetic mounting device used to temporarily mount the external antenna to a flat metal surface.



Ordering Instructions (Mail, FAX, or Phone)

By Mail: Complete the order form provided with this manual, adding shipping and handling changes, and sales tax where applicable. Include a check, money order or credit card information and send it to:

Magellan Systems Corporation
Attention Order Department
960 Overland Court
San Dimas, CA 91773-1742 USA

By FAX: Complete the order form, adding shipping and handling charges, and sales tax where applicable. Include your credit card information and FAX the form to (909) 394-7050.

By Phone: Complete the order form provided with this manual, adding shipping and handling changes, and sales tax where applicable. Have the order form and your credit card information ready and phone the Magellan Order Hotline at (909) 394-6067. You can then place your order via voice mail. Please leave your phone number should we need to contact you concerning your order.

List of Available Datums

WGS84	World Geodetic System	INDIA	Indian (India, Nepal)
NAD27	North American 1927	IRAN	Iran
NAD83	North American 1983	IRELA	Ireland 1965
ADIND	Adinda	KAUAI	Kauai
ALASK	Alaska	KERTA	Kertau 1948
ARC50	Arc 1950	KKJ	KKJ (Finland)
ARC60	Arc 1960	LIBER	Liberia 1964
ASTRO	Camp Area Astro	LUZON	Luzon
AUS66	Australian Geodetic 1966	MASSA	Massawa
AUS84	Australian Geodetic 1984	MAUI	Maui
BOGOT	Bogota Observatory	MERCH	Merchich
BUKIT	Bukit Rimpah	MINNA	Minna
CAMPO	Campo Inchauspe	MONTJ	
CANAD	Canada	NAHRW	Nahrwan, Saudi Arabia
CAPE	Cape	OAHU	Oahu
CARTH	Carthage	OEGYP	Old Egyptian
CENAM	Central America	OHAWA	Old Hawaiian
CHATH	Chatham 1971	OMAN	Oman
CHUAA	Chau Astro	PITCA	Pitcairn Astro 1967
CORRE	Corrego Alegre	QATAR	Qatar National
CYPRU	Cyprus	QORNO	Qornoq
DJAKA	Djakarta (Batavia)	RT90	Rt90 (Sweden)
EGYPT	Egypt	SAM56	Provisional So. Am. 1956
EUROP	European 1950 (All of Europe)	SAM69	South American 1969
EUR50	European 1950 (W. Europe)	SCHWA	Schwarzeck
EUR79	European 1979	SICIL	Sicily
GANDA	Gandajika Base	SIERR	
GEO49	Geodetic Datum 1949	SWISS	
GHANA		IANAN	Iananarive Observatory 1925
GRB36	Ordnance Survey of GB, 1936	THAI	Indian (Thailand, Vietnam)
GUAM	Guam	TIMBA	Timbalai
GUNSG	G. Segara	TOKYO	Tokyo
GUNSR		VOIRO	
HAWAI	Hawaii	WGS72	World Geodetic System 1972
HERAT	Herat North	YACAR	Yacare
HJORS	Hjorsey 1955	ZANDE	Zanderij
HUTZU	Hu-tzu-shan		

NMEA Message Sets

Data Transfer

Your GPS receiver can be set to output GPS data in the NMEA 0183 format to interface with other marine devices.



The dataport must be turned on and the output message format selected in SETUP.

NMEA DATA MESSAGES. NMEA data is output at the baud rate selected in Setup, 8, N, 1, checksum off. These settings are acceptable to most equipment and software applications.

There are several NMEA output message sets, each with a slightly different application. Check the documentation for your external equipment to select the appropriate message set.

SET OUTPUT/USAGE

- | | |
|-------|---|
| 0183A | BWC, APA, GLL, VTG
Remote displays, version 1.x marine autopilots |
| 0183B | RMC, RMB
NMEA-recommended navigation data for remote map, etc. |
| 0183C | APB, GGA, BWC, GLL, VTG
Version 2.0 marine autopilot data and satellite data |

NMEA Message Definitions

- | | |
|-----|---|
| APA | Autopilot cross track error, direction to steer, status of GPS, route status, destination waypoint name, and bearing from origin to destination (old format). |
| APB | Revised autopilot message contains all of the above plus: heading to steer toward destination, bearing from the present position to the destination (magnetic or true). |
| BWC | Range and bearing to a waypoint |
| GGA | GPS position, time, fix quality, number of satellites used, HDOP (Horizontal Dilution of Precision), differential reference information, and age. |
| GLL | GPS-derived latitude, longitude, and time of fix. |
| RMB | Data status, cross track error, direction to steer, origin, destination waypoint, waypoint location, bearing to destination, and velocity toward the destination. |

RMC Time, latitude, longitude, speed over ground, course over ground, and date.

VTG Track (magnetic and true) and groundspeed (knots and KPH).

OUTPUT DATA FORMAT

APA Autopilot Format A

1 2 3 4 5 6 7 8 9 10
APA,A,A,X.XX,L,N,A,A,XXX.,M,CCC

- 1 OR'ed Blink and SNR (A = valid, V = invalid)
- 2 Cycle Lock (A = valid, V = invalid)
- 3-5 Cross Track, Sense (L = steer left, R = steer Right), N.Mi. Units
- 6-7 Arrival Circle, Arrival Perpendicular (crossing of the line which is perpendicular to the course line and which passes through the destination waypoint.
- 8-9 Bearing dest. wpt. from origin wpt., Magnetic
- 10 Dest wpt. identifier

APB Autopilot Sentence "B"

1 2 3 4 5 6 7 8 9 10 11 12 13 14
APB,A,A,X.x,a,N,A,A,x.x,a,c-c,x.x,a,x.x,a*hh

- 1 Status: V = Loran-C Blink or SNR warning
A = general warning flag for other navigation systems when a reliable fix is not available.
- 2 Status: V = Loran-C cycle lock warning flag
A = OK or not used
- 3 Magnitude of XTE
- 4 Direction to steer (L, R)
- 5 XTE units, nautical miles
- 6 Status: A = arrival circle entered
- 7 Status: A = perpendicular passed at waypoint
- 8-9 Bearing origin to destination, M/T
- 10 Destination waypoint ID
- 11-12 Bearing, present position to destination, Magnetic or True
- 13-14 Heading to steer to destination waypoint, Magnetic or True

BWC To Selected Waypoint, Great Circle

1 2 3 4 5 6 7 8 9 10 11 12
BWC, XXXXXX, XXXX.XX, N, XXXXX.XX, W, XXX., T, XXX., M, XXX.X, N, CCCC

- 1 UTC of Bearing
- 2-3 Lat. N or S of waypoint
- 4-5 Long, E or W of waypoint
- 6-7 Bearing, True
- 8-9 Bearing, Magnetic
- 10-11 Distance, naut. miles
- 12 Waypoint identifier

GGA Global Positioning System Fix Data

1 2 3 4 5 6 7 8 9 10 11
GGA, hhhmss.ss, lll.ll, a, yyyyy.yy, a, x, xx, x.x, x.x, M, x.x,
12 13 14
M, x.x, xxxx*hh

- 1 UTC of Position
- 2-3 Latitude - N/S
- 4-5 Longitude - E/W
- 6 GPS Quality Indicator
 - 0 = fix not available or invalid
 - 1 = GPS Fix
 - 2 = Differential GPS Fix
- 7 Number of satellites in use
- 8 Horizontal dilution of precision
- 9 Antenna altitude above/below mean sea level
- 10 Units of antenna altitude
- 11 Geoidal separation - difference between the WGS-84 earth ellipsoid and mean sea level (geoid), "-" = mean sea level below ellipsoid
- 12 Units of geoidal separation, meters.
- 13 Age of Differential GPS data - Time in seconds since last SC104 Type 1 or 9 update, null field when DGPS is not used
- 14 Differential reference station ID, 0000-1023

GLL Geographic Position — Latitude/Longitude

1 2 3 4 5 6
GLL,1111.11,a,YYYYY.YY,a,hmmss.ss,A*hh

- 1-2 Latitude, N/S
- 2-3 Longitude, E/W
- 4 UTC of position
- 6 Status A = Data valid

RMB Generic Navigation Information (immediately follows RMC)

1 2 3 4 5 6 7 8 9 10 11 12
RMB,A,X.XX,L,CCCC,CCCC,SSS.SS,N,XXXXX.XX,W,XXX.X,XXX.,XX.X,

13 14
A *XX

- 1 Status (A = valid, V = invalid)
- 2-3 XTE, naut. miles and direction to steer (L or R) [If XTE exceeds 9.99 NM, display 9.99 in field 2.]
- 4 Origin waypoint ID
- 5 Destination waypoint ID
- 6-7 Destination Waypoint Latitude (N or S)
- 8-9 Destination Waypoint Longitude (E or W)
- 10 Range naut. miles, present fix to destination waypoint Great Circle. [If range exceeds 999.9 nm, display 999.9.]
- 11 Bearing, True, Great Circle, Present fix to dest. waypoint
- 12 Closing velocity to destination, knots
- 13 Arrival (OR'ed arrival circle and crossing of line which is perpendicular to the course line and which passes through the destination waypoint.)
- 14 CHECKSUM (Mandatory in this sentence.)

RMC Transit Specific (to be followed by RMB)

1 2 3 4 5 6 7 8 9 10
12
RMC,XXXXXX,A,XXXX.XX,N,XXXXX.XX,W,XX.X,XXX.,XXXXXX,XX.,E
*XX

- 1 Time, UTC
- 2 Status (A = valid, V = invalid)
- 3-4 Latitude at UTC time, N or S
- 5-6 Longitude at UTC time, E or W
- 7 Speed over ground, knots
- 8 COG (track), degrees
- 9 Date (DDMMYY)
- 10 Variation, degrees
- 11 Variation, sense (E or W)
- 12 CHECKSUM (Mandatory in this sentence)

VTG Actual Track and Ground Speed (SOG)

1 2 3 4 5 6 7 8
VTG,XXX.,T,XXX.,M,XX.X,N,XX.X,K
1-2 Track degrees, True
3-4 Track degrees, Magnetic
5-6 Speed, knots
7-8 Speed, kilometers/hour

The formats listed are NMEA formats and Magellan receivers may not output all of the information listed for a particular format.

City Reference Chart

Australia & SW Pacific

Adelaide	34°55.00 S	138°35.00 E
Alice Springs	23°42.00 S	133°53.00 E
Apia	13°48.00 S	171°45.00 W
Auckland	36°55.00 S	174°47.00 E
Bourail	21°34.00 S	165°29.00 E
Brisbane	27°28.00 S	153°02.00 E
Canberra	35°17.00 S	149°08.00 E
Cooper Pedy	28°56.00 S	134°45.00 E
Dampier	20°45.00 S	116°48.00 E
Darwin	12°28.00 S	130°50.00 E
Derby, WA	17°19.00 S	123°38.00 E
Honiara	9°28.00 S	159°57.00 E
Iron Range	12°39.00 S	143°13.00 E
Mount Isa	20°50.00 S	139°29.00 E
Nadi	17°47.00 S	177°29.00 E
Newman, Mt.	23°20.00 S	119°34.00 E
Ooldea	30°30.00 S	131°45.00 E
Perth	31°56.00 S	115°50.00 E
Port Moresby	9°30.00 S	147°07.00 E
Rawlinna	31°00.00 S	125°21.00 E
Timaru	44°23.00 S	171°14.00 E
Townsville	19°13.00 S	146°48.00 E

Asia

Bangalore	12°58.00 N	77°35.00 E
Bangkok	13°44.00 N	100°30.00 E
Beijing	39°55.00 N	116°26.00 E
Bombay	18°56.00 N	74°35.00 W
Calcutta	22°30.00 N	88°20.00 E
Colombo	6°55.00 N	79°52.00 E
Delhi	28°40.00 N	77°14.00 E
Hanoi	21°01.00 N	105°52.00 E
Harbin	45°45.00 N	126°41.00 E
Ho Chi Minh City	10°46.00 N	106°43.00 E
Hong Kong	22°15.00 N	114°10.00 E
Islamabad	33°40.00 N	73°08.00 E
Jakarta	6°08.00 S	106°45.00 E
Kagoshima	31°37.00 N	130°32.00 E
Kandla	23°03.00 N	70°11.00 E
Karachi	24°51.00 N	67°02.00 E
Kathmandu	27°42.00 N	85°19.00 E
Kinabalu, Gunung	6°03.00 S	116°32.00 E
Kota, Malaysia	2°33.00 N	102°10.00 E
Kuala Lumpur	3°08.00 N	101°42.00 E
Kunming	25°04.00 N	102°41.00 E
Malang	7°59.00 S	112°45.00 E
Mandalay	21°57.00 N	96°04.00 E
Nagpur	21°10.00 N	79°12.00 E
Padang	6°12.00 S	100°27.00 E
Palu	8°19.00 S	121°44.00 E
Pinang	5°30.00 N	100°28.00 E
Pontianak	0°05.00 S	109°16.00 E
Rangoon	16°47.00 N	96°10.00 E
Sapporo	43°05.00 N	141°21.00 E
Seoul	37°30.00 N	127°00.00 E
Shanghai	31°06.00 N	121°22.00 E
Sorong	0°50.00 S	131°17.00 E
Surakarta	7°32.00 S	110°50.00 E
Tanahmerah	6°08.00 S	140°18.00 E
Tapei	25°05.00 N	121°32.00 E
Thimphu	27°32.00 N	89°43.00 E
Tokyo	35°40.00 N	139°45.00 E

Tonhil	46°19.00 N	93°54.00 E
Ulaanbaatar	47°54.00 N	106°52.00 E
Ürümqi	43°43.00 N	87°38.00 E
Wuhan	30°35.00 N	117°55.00 E
Xi'an	34°16.00 N	108°54.00 E
Yumen	39°54.00 N	97°43.00 E

CIS

Anadyr	64°50.00 N	177°50.00 E
Arkhangel'sk	64°32.00 N	40°40.00 E
Ashkhabad	37°58.00 N	58°24.00 E
Baku	40°22.00 N	49°53.00 E
Balkhash	46°50.00 N	74°57.00 E
Barnaul	53°21.00 N	83°45.00 E
Chita	52°03.00 N	113°35.00 E
Gizhiga	62°00.00 N	160°34.00 E
Igarka	67°31.00 N	86°33.00 E
Inarigda	63°15.00 N	107°40.00 E
Kargasok	59°07.00 N	80°58.00 E
Khatanga	71°59.00 N	102°31.00 E
Kiyev	50°25.00 N	133°43.00 E
Krasnodar	45°02.00 N	39°00.00 E
Magdagachi	53°27.00 N	125°44.00 E
Moscow	55°45.00 N	37°42.00 E
Okhotsk	59°20.00 N	143°15.00 E
Perm	58°01.00 N	56°10.00 E
Petropavlovsk	54°53.00 N	69°13.00 E
Riga	56°40.00 N	106°10.00 E
Saratov	51°30.00 N	45°55.00 E
Tashkent	41°16.00 N	69°13.00 E
Tulun	54°32.00 N	100°35.00 E
Vanino	49°05.00 N	140°14.00 E
Vladivostok	43°09.00 N	131°53.00 E
Vorkuta	67°27.00 N	64°00.00 E
Yakutsk	62°10.00 N	129°50.00 E

Middle East

Al Kuwait	29°20.00 N	48°00.00 E
Ar Riyad	24°39.00 N	46°46.00 E
Baghdad	33°20.00 N	44°26.00 E
Bam	36°57.00 N	57°56.00 E
Halab	36°14.00 N	37°10.00 E
Herat	34°20.00 N	62°12.00 E
Jerusalem	31°47.00 N	35°13.00 E
Kabul, Afghanistan	34°31.00 N	69°12.00 E
Mashhad, Iran	36°16.00 N	59°34.00 E
Nazwa	22°56.00 N	57°33.00 E
Salalah	17°00.00 N	54°04.00 E
San'a	15°24.00 N	44°14.00 E
Shiraz	29°38.00 N	52°34.00 E
Tabriz	38°05.00 N	46°18.00 E
Tarim	16°08.00 N	48°58.00 E
Tehran	35°40.00 N	51°26.00 E

Africa

Abidjan	5°19.00 N	0°05.00 W
Ad Dakhla	23°43.00 N	15°57.00 W
Adis Abeba	9°03.00 N	38°42.00 E
Alger	36°50.00 N	3°00.00 E
Antananarivo	18°52.00 S	47°30.00 E
Asmera	15°20.00 N	38°58.00 E
Aswan	24°05.00 N	32°56.00 E
Bamako	12°39.00 N	8°00.00 W



Banghazi	32°07.00 N	20°04.00 E	Oslo	59°55.00 N	10°45.00 E
Bangui	4°22.00 N	18°35.00 E	Paris	48°52.00 N	2°20.00 E
Beira	19°49.00 S	34°52.00 E	Reykjavik	64°09.00 N	21°51.00 W
Cairo	30°03.00 N	31°15.00 E	Scoresbysund	70°30.00 N	22°00.00 W
Capetown	33°55.00 S	18°22.00 E	Stensele	65°05.00 N	17°10.00 E
Dakar	14°40.00 N	17°26.00 W	Stockholm	59°20.00 N	18°03.00 E
Fés	34°05.00 N	5°00.00 W	Thule	76°35.00 N	68°30.00 W
Freetown	8°30.00 N	13°15.00 W	Torshavn	62°02.00 N	6°47.00 W
Harare	17°50.00 S	31°03.00 E	Trabzon	41°00.00 N	39°43.00 E
Kabwe	14°29.00 S	28°25.00 E	Vardo	60°16.00 N	20°20.00 E
Kampala	0°19.00 N	32°25.00 E			
Kano	12°00.00 N	8°31.00 E	The Americas		
Khartoum	15°36.00 N	32°32.00 E	Albany, NY	42°39.00 N	73°45.00 W
Kinshasa	4°18.00 S	15°18.00 E	Albuquerque	35°05.00 N	106°39.00 W
Kisangani	0°33.00 N	25°14.00 E	Amarillo	35°14.00 N	101°50.00 W
Lagos	6°27.00 N	3°24.00 E	Antofagasta	23°40.00 S	70°23.00 W
Las Palmas de GC	28°08.00 N	15°27.00 W	Arequipa	16°25.00 S	71°32.00 W
Lindi	10°00.00 S	39°41.00 E	Atlanta	33°44.00 N	84°23.00 W
Lobito	12°20.00 S	13°34.00 E	Baton Rouge	30°27.00 N	91°09.00 W
Lomé	6°08.00 N	1°13.00 E	Belem	1°27.00 S	48°29.00 W
Lubumbashi	11°41.00 S	27°29.00 E	Billings, MT	45°47.00 N	108°30.00 W
Lüderitz	26°38.00 S	15°10.00 E	Birmingham	33°31.00 N	86°48.00 W
Lusambo	4°59.00 S	23°26.00 E	Bismarck	46°48.00 N	100°47.00 W
Maputo	25°58.00 S	32°35.00 E	Bogotá	4°36.00 N	74°05.00 W
Maseru	29°19.00 S	27°29.00 E	Boise	43°36.00 N	116°12.00 W
Mbale	1°04.00 N	34°12.00 E	Boston	42°21.00 N	71°03.00 W
Mogadishu	2°02.00 N	45°21.00 E	Brasilia	15°47.00 S	47°55.00 W
Monrovia	6°18.00 N	10°47.00 W	Buffalo, NY	42°52.00 N	78°55.00 W
Mwanza, Zaire	7°51.00 S	26°43.00 E	Caracas	10°30.00 N	66°56.00 W
N' Djamena	12°10.00 N	14°59.00 E	Casper	42°50.00 N	106°20.00 W
Nairobi	1°17.00 S	36°49.00 E	Cayenne	4°56.00 N	52°20.00 W
Namibe	15°10.00 S	12°09.00 E	Chicago	41°51.00 N	87°39.00 W
Nouakchott	18°09.00 N	15°58.00 W	Chihuahua	28°40.00 N	106°06.00 W
Ouagadougou	12°22.00 N	1°31.00 W	Churchill, CAN	58°45.00 N	94°00.00 W
Pointe Noire	4°46.00 S	11°53.00 E	Cleveland	41°29.00 N	81°41.00 W
Port Elizabeth	33°58.00 S	25°36.00 E	Comodoro R	45°50.00 S	67°30.00 W
Sabha, Libya	27°02.00 N	14°26.00 E	Coppermine	67°49.00 N	115°21.00 W
Serowe	22°25.00 S	26°44.00 E	Córdoba, Veracruz	18°55.00 N	96°55.00 W
Sidi Ifni	29°24.00 N	10°12.00 W	Cuiabá	7°15.00 S	58°25.00 W
Toliara	23°20.00 S	43°41.00 E	Dallas	32°46.00 N	96°47.00 W
Tombouctou	16°49.00 N	2°59.00 W	Denver	39°44.00 N	104°59.00 W
Tripoli	32°54.00 N	13°11.00 E	Des Moines	41°36.00 N	93°36.00 W
Tsumeb	19°13.00 S	17°42.00 E	Detroit	42°20.00 N	83°03.00 W
Tunis	36°48.00 N	10°11.00 E	Duluth	46°45.00 N	92°10.00 W
Winhoek	22°34.00 S	17°06.00 E	Fort McPherson	67°29.00 N	134°50.00 W
Yaounde	3°52.00 N	11°31.00 E	Fort Providence	61°03.00 N	117°40.00 W
Zanzibar	6°10.00 S	39°20.00 E	Georgetown, Guy.	6°48.00 N	58°10.00 W
			Grand Rapids, MI	42°57.00 N	86°40.00 W
Europe			Guadalajara	20°40.00 N	103°20.00 W
Athens	37°58.00 N	23°43.00 E	Guantánamo	20°09.00 N	75°14.00 W
Barcelona	41°23.00 N	2°11.00 E	Guatemala	14°38.00 N	90°31.00 W
Bern	46°57.00 N	7°26.00 E	Guayaquil	2°10.00 S	79°50.00 W
Bordeaux	44°50.00 N	0°34.00 W	Hazelton, BC	55°15.00 N	127°38.00 W
Bрно	49°13.00 N	16°40.00 E	Houston	29°45.00 N	95°21.00 W
Bucuresti	44°26.00 N	26°06.00 E	Ilhéus	14°50.00 S	39°06.00 W
Budapest	47°30.00 N	19°05.00 E	Indianapolis	39°46.00 N	86°09.00 W
Cork	51°54.00 N	8°28.00 W	Iquitos	3°51.00 S	73°13.00 W
Gdansk	54°23.00 N	18°40.00 E	Kansas City, MO	39°02.00 N	94°33.00 W
Glasgow	55°53.00 N	4°15.00 W	La Habana	23°08.00 N	82°22.00 W
Godthåb	64°11.00 N	51°44.00 W	Labrador City	52°56.00 N	66°52.00 W
Hamburg	53°33.00 N	9°59.00 E	Las Vegas	36°10.00 N	115°08.00 W
Istanbul	41°01.00 N	28°58.00 E	Lima	12°03.00 S	77°03.00 W
London	51°30.00 N	0°10.00 W	Little Rock	34°44.00 N	92°17.00 W
Longyearbyen	78°12.00 N	15°40.00 E	Los Angeles	34°03.00 N	118°14.00 W
Madrid	40°24.00 N	3°41.00 W	Louisville	38°15.00 N	85°45.00 W
Napoli	40°51.00 N	14°17.00 E	Managua	12°06.00 N	86°18.00 W
Nice	43°42.00 N	7°15.00 E	Manaus	3°06.00 S	60°00.00 W
Nuugaatsiaq	71°30.00 N	53°00.00 W	Merida, Venezuela	8°24.00 N	71°08.00 W



Miami	25°46.00 N	80°11.00 W
Milwaukee	43°02.00 N	87°54.00 W
Minneapolis	44°58.00 N	93°15.00 W
Montevideo, Uru.	34°53.00 S	56°11.00 W
Nakina	59°12.00 N	132°48.00 W
Nashville, TN	36°09.00 N	86°47.00 W
New York	40°43.00 N	74°01.00 W
Norfolk, VA	36°50.00 N	76°17.00 W
Oklahoma City	35°28.00 N	97°30.00 W
Omaha	41°15.00 N	95°56.00 W
Panama City	8°58.00 N	79°32.00 W
Peace River	56°15.00 N	117°18.00 W
Peoria, IL	40°43.00 N	89°38.00 W
Phoenix	33°26.00 N	112°04.00 W
Pittsburgh	40°26.00 N	79°59.00 W
Port-au-Prince	18°32.00 N	72°20.00 W
Portland, OR	45°31.00 N	122°40.00 W
Porto Velho	8°45.00 S	63°54.00 W
Québec	46°50.00 N	71°15.00 W
Rapid City, SD	44°06.00 N	103°14.00 W
Recife	8°06.00 S	34°53.00 W
Reno	39°32.00 N	119°49.00 W
Rio de Janeiro	22°54.00 S	43°14.00 W
Salt Lake City	40°45.00 N	111°53.00 W
San Antonio	29°25.00 N	98°29.00 W
San Francisco	37°46.00 N	122°25.00 W
San Juan	18°28.00 N	66°07.00 W
Santarém	2°26.00 S	54°41.00 W
São Paulo	23°32.00 S	46°37.00 W
Saskatoon	52°10.00 N	101°32.00 W
Seattle	47°36.00 N	122°19.00 W
Shreveport	32°30.00 N	93°46.00 W
Sioux Falls	43°34.00 N	96°42.00 W
Spokane	47°40.00 N	117°25.00 W
St Louis	38°37.00 N	90°11.00 W
Tampa, FL	27°58.00 N	82°38.00 W
Tijuana	32°32.00 N	117°01.00 W
Toronto	43°39.00 N	79°23.00 W
Valparaiso, Brazil	21°16.00 S	50°54.00 W
Vancouver	49°16.00 N	123°07.00 W
Veracruz	19°12.00 N	96°08.00 W
Washington	38°53.00 N	77°02.00 W
Whitehorse	60°43.00 N	135°03.00 W
Wichita	37°43.00 N	97°20.00 W
Winnipeg	49°53.00 N	97°09.00 W

Pacific Ocean

American Samoa	14°20.00 S	170°00.00 W
Baker I.	0°12.00 N	176°28.00 W
Easter I.	27°05.00 S	109°20.00 W
Gambier I.	23°10.00 S	135°00.00 W
Honolulu	21°18.00 N	157°51.00 W
Howland I.	0°48.00 N	176°38.00 W
Jarvis I.	0°02.00 S	160°02.00 W
Kanton I.	2°50.00 S	171°40.00 W
Lihue	21°59.00 N	159°23.00 W
Palmyra I.	5°52.00 N	162°05.00 W
Pitcairn I.	25°04.00 S	130°06.00 W
Swains I.	59°30.00 S	100°00 W

Abbreviations and Data Terms

EXPLANATION OF DATA TERMS

BRG. Bearing is the direction, as measured in degrees from north in a clockwise direction. The receiver uses either true north or magnetic north, as selected in the Setup Menu. The illustration shows a simple compass rose with the eight cardinal directions noted with their bearing.

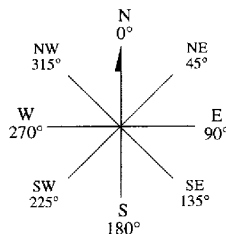

ETE. Estimated time en route to active waypoint.

DST. Distance to go to an active waypoint, or the distance between two waypoints in a route leg.

CTS. The optimum direction the vessel should be steered in order to efficiently make headway back to the courseline while also proceeding toward the destination waypoint. It is a "compromise" course bearing that projects from your current position to a point on the courseline mid-way between a point perpendicular to your position and the current leg destination waypoint.

STR. The difference between COG and BRG. If BRG is 180° and COG is 183°, then STR is 3° Left.

COG. Course over ground is the direction of movement expressed as bearing. If a boat is pointing exactly north (0°) and there are no other factors affecting its travel, the COG would be 0° but that is rarely the case. Water currents and wind can affect the course the boat is taking.

If there is a current passing from left to right across the boat (90°) the COG would change even though the bow of the boat is still pointing north. COG is measured in degrees with North being 0°.

XTE. XTE (cross track error) is the distance to the left or right of the courseline that you are travelling. As you will see in the discussion of other data items, XTE is important in computing them accurately.

Keeping XTE at a minimum will help maintain the most direct route to your destination. This illustration shows a boat and the courseline. The arrows between the boat and the courseline is the distance of XTE that this boat is to the left of the courseline. This boater would need to steer right to close the XTE.

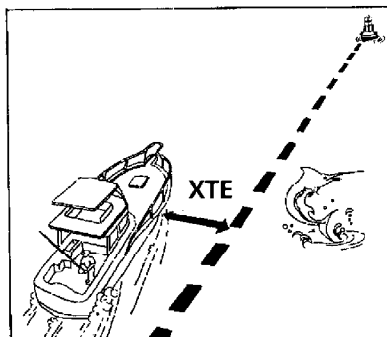

SOG. Speed over ground is the speed at which the vehicle/vessel is moving in respect to the earth. SOG is sometimes referred to as ground speed and is measured in knots, miles per hour, and kilometers per hour. (This is not the same as speed through water.)

SOA. Understanding speed of advance is a little tricky but once you do it becomes fairly simple. For this example we will use an exaggerated sample so as to clearly describe SOA.

The boat is heading towards the buoy and is currently at point A. If the boat had followed its original course ($A_1 - B_1$), it would be somewhere on the line $A_1 - B_1$. (The XTE for this sample is the distance between points A and A_1 .) In 1 hour he is at point B and has travelled 34 NM (equivalent to a speed of 34 knots).

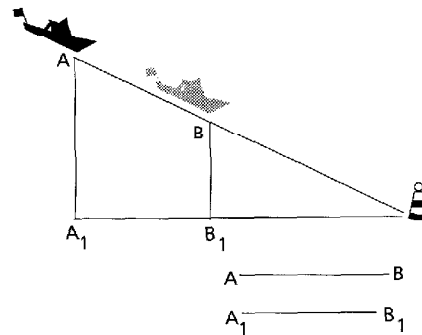

Now if you project downwards to the course he should be on, you arrive at point B₁.

Comparing the lines from points A and B and from points A₁ and B₁, you see that while the boat travelled 34 NM it only moved 30 NM along the course line. If he moves 30 NM on the course line in 1 hour, his SOA is 30 knots, whereas SOG would be 34 knots.

VMG. Velocity made good is the portion of the velocity that is in the direction of the destination. In the above example, the boat is travelling directly towards the buoy even though not on the course line originally set. In this case, all of this velocity is being applied towards arriving at the destination, (i.e., $VMG = SOG$). Should the boat veer away from this course and travel in a line parallel to the original course line ($A_1; B_1$) he would be travelling on a course that would not intercept the buoy waypoint. As the boat moved along, less and less of his velocity would be applied toward arriving at the buoy. By the time point D is reached, none of the velocity is applied to getting closer to the buoy and the VMG would be 0. As he moves to point E, he is moving away from the buoy and his VMG is a negative value.

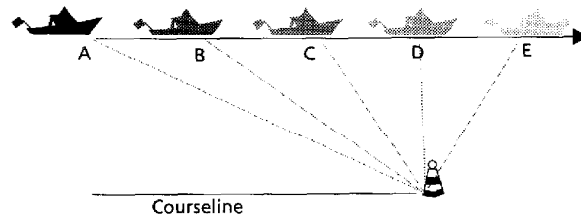

Specifications

Specifications [Meridian XL]

Size	6.125" x 3.5" x 1.25", not including antenna (15.6 cm x 8.9 cm x 3.2 cm)
Weight	14 ounces (0.397 kg), with batteries installed
Temperature:	
Operating	14°F to 140°F (-10°C to 60°C)
Storage	-40°F to 167°F (-40°C to 75°C)
Case	waterproof (non-submersible)
Antenna	detachable quadrifilar

Specifications [NAV 1200XL]

Size	6.9" x 3.835" x 1.362" (17.53 cm x 9.185 cm x 3.46 cm)
Weight	13.9 ounces (394 kg)
Temperature:	
Operating	14°F to 122°F (-10°C to 50°C)
Storage	-40°F to 158°F (-40°C to 70°C)
Case	splashproof
Antenna	separate low-profile patch

Operating Characteristics

Accuracy:	
Position	12 meters RMS in 3D operation without SA
Velocity	0.5 meters/second RMS
Speed limit	up to 951 MPH (1,530 kilometers per hour)
Elevation limit	upper limit 57,414 feet (17,500 meters) lower limit -328 feet (-100 meters)
Time to First Fix:	
Cold start*	3 minutes or less
Warm start*	1 minute
* Warm start:	the receiver has obtained a position fix within the last 2 hours. Cold start: the receiver has been idle for 2 hours or longer.
Storage capacity	up to 200 waypoints, up to five 15-leg routes
After memory loss	15 minutes or more
Update rate	every second

Coordinate Systems

Positions are locations that are described in a unique way so that one location cannot be confused with another. This is done by using a coordinate system to describe locations. Your Magellan receiver has the ability to use any one of four different coordinate systems; LAT/LON (latitude and longitude), TD (Time Difference of Arrival), UTM (Universal Transverse Mercator), and OSGB. The one you select (in SETUP) will be determined by the maps and charts you use; you would generally want the receiver to display position coordinates in the same system that is used by your maps.

LAT/LON Coordinate System. LAT/LON is the most commonly used coordinate system today. It projects lines of latitude (parallels) and lines of longitude (meridians) onto the earth's surface. Lines of latitude are the equator and the horizontal lines that are parallel to it. Lines of longitude are the vertical lines that are perpendicular to the equator and pass through the poles. A position is described as being the intersection of a line of latitude and a line of longitude.

Specifically, a position is so many degrees north or south of the equator (up to the poles, which are 90°N and 90°S; the equator is 0° latitude), and so many degrees east or west of the Prime Meridian, which is 0° longitude. (The Prime Meridian passes through Greenwich, England.) Parts of a degree are minutes; there are 60 minutes (written as 60') to a degree. Minutes can also be divided into smaller units. Fractions of a minute can be expressed as decimals or as seconds. (There are 60 seconds to one minute, written as 60"). So a Lat/Lon position coordinate can be expressed in two ways, which your Magellan GPS receiver displays as 25°47.50 or 25°47'30.

UTM Coordinate System. Another commonly used coordinate system is UTM (Universal Transverse Mercator), which is generally found on land-based maps and quad sheets that are produced by government map providers. On land, you may find that UTM coordinates are easier to use than Lat/Lon.

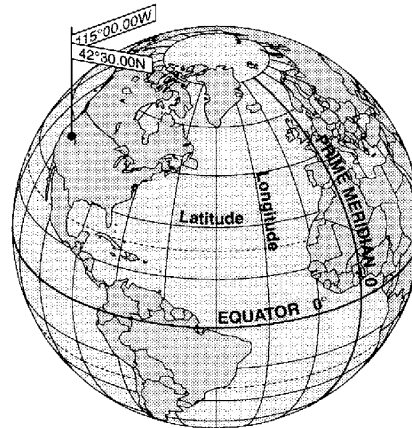

UTM coordinates are easy to use, but since the model it is based on is somewhat abstract, this section is a very simplified introduction to UTM.

Instead of projecting an imaginary grid of intersecting lines onto the globe, UTM projects sections of the globe onto a flat surface. Each of these sections is called a "zone." There are 60 zones to cover the entire earth between 84°N and 80°S (polar areas are not described by UTM). Each zone is 6° wide as projected from the earth's center.

A UTM position is described by three elements; the zone it is in, the easting, and the northing. Eastings and northings measure how far into a zone a position is in meters. Eastings are an east/west measurement, and correspond roughly to longitude. Northings are a north/south measurement, and correspond to latitude.

This chart shows the position of Magellan Systems described in both Lat/Lon and UTM coordinates.

LAT/LON		UTM
DEG/MIN	DEG/MIN/SEC	
34°06.58N	34°06'35"N	11 4 23 818 E
117°49.56W	117°49'34"W	37 74 624 N

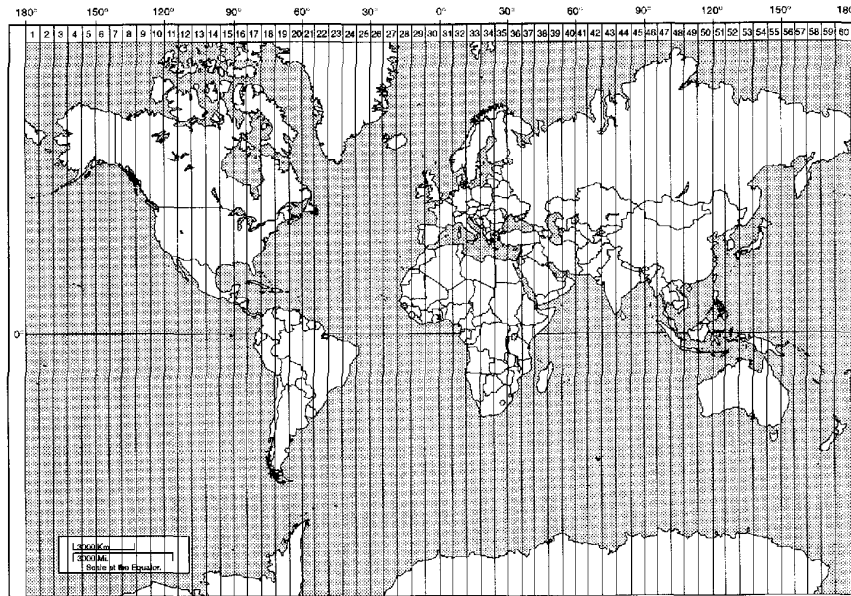

NOTE: The area described by the UTM coordinate system extends to 84°N and to 80°S.



TD Coordinate System. TDs are indicated on many nautical charts in addition to the LAT/LON marks. They are established lines of position (LOPs) that are determined by the difference in the length of time required to receive Loran-C signals. Many coastal navigators use TDs because Loran is a familiar radio aid navigation and TDs are clearly marked on their charts. The Meridian XL and NAV 1200XL can display position coordinates in TDs by converting from position fixes calculated in Lat/Lon. (No measurements are made using the Loran signals.)

To use TDs, the Loran receiver is set to a specific chain of stations; each Loran chain consists of one master station (designated as M) and two or more secondary stations (W, X, Y, and Z). Next, the navigator determines which two secondary stations will provide the most accurate position fix based on the angle of intersection of the LOPs. The TD measurement is the difference between the time it takes a signal to arrive from the master station and the time it takes to arrive from a secondary station to your location. This is referred to as a TD. Two TDs are required for a position fix.

Meridian XL and NAV 1200XL displays position coordinates in TDs by converting the LAT/LON coordinates to TDs, mathematically, using the GRI (chain number) and secondary beacons you entered when selecting the TD coordinate system.

When TD is selected in Setup under COORD SYS you will be asked to select the following

- 1) The GRI (also called the chain) that you will be navigating in.
- 2) The two secondary stations that will provide you with the best angle of LOP intersections. If you have used Loran in the past, you should simply enter the values that you have used before.

Other Coordinate Systems. OSGB coordinates are similar to UTM's, but they describe only Great Britain. They must be used with the GBR36 datum, which also describes Great Britain. This coordinate system cannot be used in any other part of the world. The Meridian XL and NAV 1200XL automatically selects the GBR36 datum when the OSGB coordinate system is selected in Setup. (While OSGB coordinates must be used with the GBR36 datum, the GBR36 datum can be used with LAT/LON coordinates; just be sure the map you are using uses both LAT/LON and GBR36.)



If you select OSGB in the COORD. SYS. portion of the Setup Menu be sure to change the map datum back to the one you will be using (WGS84 is the default) when changing to another coordinate system.

Irish Grid uses the Ireland datum, Swedish Grid uses the RT90 datum, and Swiss Grid uses the Swiss datum.

General Maintenance

Meridian XL

The Meridian XL is powered by three AA batteries. It can also be powered from an external DC power source by using the optional Power/Data Cable.

Batteries

We suggest using AA alkaline batteries to power the receiver. (Magellan Systems recommends Eveready Energizer™ batteries.) Alkaline batteries will power the receiver for 5 hours or more of continuous operation.

To install the batteries, hold the receiver as shown in the illustration at the right. At the same time, press down slightly on the battery compartment cover and pull the cover toward you. Insert batteries as indicated in the compartment and replace the cover.

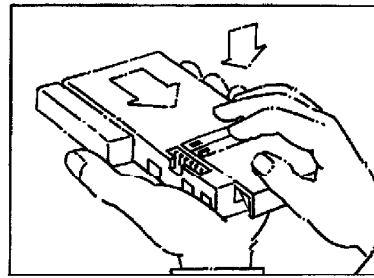

When the battery power level drops, a warning message will appear on all displays (LOW BATT). The receiver should still have sufficient power to operate for up to 30 minutes if alkaline batteries are being used.

When the batteries no longer hold enough power to operate the receiver, the receiver turns itself off. The batteries will still be able to maintain the memory for a time, but the receiver can be operated only if external power is supplied or if fresh batteries are installed.



Batteries are not recharged in the receiver.

It is possible to use rechargeable batteries, but there are a couple of things you should be aware of when using them. Commercially available NiCad batteries typically have poor power performance after repeated use, and rechargeable alkaline batteries maintain only 50% of the useful life of standard alkaline batteries. Rechargeables also have a very sudden power drop at the end of their charge. The drop may be so sudden that the battery warning is not displayed, although memory can be maintained for a while.



External Power

The Meridian XL can also be operated from an external DC power source. This requires the Power/Data Cable that is included with the optional mounting kit. (Even when operating from external power, the receiver must have batteries; the batteries will be used to maintain memory when the receiver is off.)

The cable converts DC power to a level usable by the receiver. It also can be used to output positioning data to electronic navigation equipment that conforms to NMEA standards, and to import broadcast differential corrections from a differential beacon receiver.



The use of a non-Magellan cable or an altered Magellan cable may damage the receiver and will void the warranty.

Antenna



The receiver has an attached quadrifilar antenna, which rotates 360°. Using the extension cable and suction cup provided with the optional Mounting Kit, the antenna can also be detached from the receiver and temporarily mounted to any convenient surface. (The antenna is detached by rotating it until its base is parallel with the display, then pulling it away from the receiver.) Since it can be used detached from the receiver, the antenna can be placed wherever it has the clearest view of the sky.



In order to provide the best signal reception possible, the antenna must be vertical. If attached to the receiver, rotate the antenna from its storage position to the upright position. If detached from the receiver, the antenna should be mounted as vertically as possible with the connecting cable at the bottom.

GPS signals will pass through glass and canvas (such as bimini tops) however, you may experience some signal loss in areas of heavy foliage. (Do not stand under a tree in full leaf when attempting to take a fix.) Signals will not go through metal, and you are unlikely to obtain signals in a permanent structure.

Signals can be temporarily blocked by trees, masts, and people. If you are unable to obtain satellite signals when out of doors, try moving slightly to get a better view of the sky. If the receiver is being operated in a covered location (such as a navigation station), you may want to use the optional External Antenna Kit. (Use only a Magellan antenna; the use of a non-Magellan antenna may greatly degrade the performance of the receiver.)

NAV 1200XL

The NAV 1200XL is powered by an external 9–16 VDC power source. When off, memory is maintained by an internal lithium battery. The lithium battery should have a lifetime of about 4 years.

The NAV 1200XL can be installed on the dash of an instrument panel using the U-bracket and knobs provided, or it can be flush-mounted into the instrument panel.

External Connections

The NAV 1200XL must be connected to an external power supply (usually ship power) and an external antenna. It may also be connected to an external NMEA electronic navigation device, an external alarm, and/or a compatible differential beacon receiver (to receive broadcast differential corrections).

Use the following illustration to make all necessary external connections with the provided Power/Data Cable.

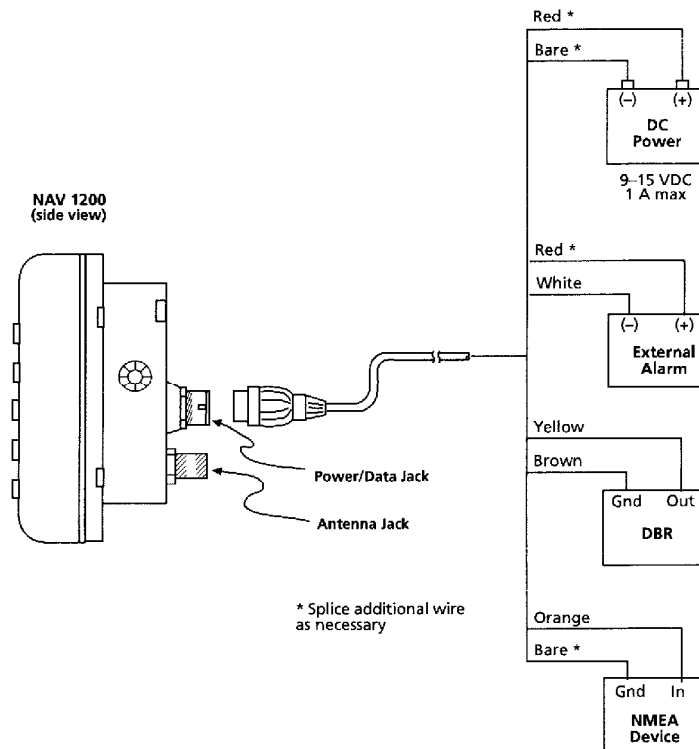



U-Bracket Installation

Use the following procedure to install the receiver in the U-bracket.

1. Position the U-bracket on any flat, reasonably level surface. Use the bracket as a template to mark the location of the mounting holes.
2. Drill pilot holes at the two marks, then screw the U-bracket to the surface.
3. Thread the knobs provided into the bracket arms from the outside. Next, place a rubber washer (also provided) on the shaft of each knob.
4. Position the NAV 1200XL between the bracket arms, tilted to a comfortable viewing angle. Secure by tightening the knobs. The provided washers should be placed between the U-bracket and the receiver.

Flush-Mounting

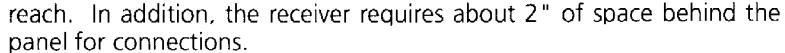

The NAV 1200XL can be permanently mounted in an instrument panel. When deciding where to position the receiver, be sure to choose a location where the display will be clearly visible and the receiver is within easy reach. In addition, the receiver requires about 2" of space behind the panel for connections.

1. Hold the template against the instrument panel and mark a cutting line and the locations of the mounting holes.
2. Cut along the marks made above and drill pilot holes.
3. Thread all connecting wires (for external power, the antenna and any external NMEA device the NAV 1200XL will be connected to) through the opening in the panel. Make all necessary connections to the back of the receiver.
4. Slide the receiver into the opening and secure with appropriate mounting hardware.

Flush-Mounting the Antenna

The Magellan external antenna can be permanently mounted to any stable, reasonably flat surface that provides a clear view of the sky. It should not be positioned next to a mast or other large installation.

1. Decide where the antenna is to be mounted, then drill a hole for the cable and remove any sharp or jagged edges.

- 
2. Coil the cable in the detent on the underside of the antenna. Position the antenna so the cable is over the hole, then draw a line around the outside of the antenna. Remove the antenna and place the rubber gasket (supplied) inside the outline and mark the screw holes.
 3. Drill a pilot hole for each screw.
 4. Thread the antenna cable through the gasket, then into the hole you drilled in step 1. Route the cable to the receiver installation. (Avoid making sharp turns with the cable.)
 5. If desired, apply a bead of clear silicone RTV inside the pencil outline and around each screw hole. Position the gasket over the RTV so the screw holes are aligned. Next, apply another bead of RTV on the gasket, also along the edge of the gasket and around the screw holes.
 6. Position the antenna so its screw holes are aligned with the holes in the gasket, and secure with the screws provided.

Pole Installation of the Antenna

If you prefer, the antenna can be installed on the top of a pole.

A pole installation will require the use of the included antenna mount, which has a 1"-14 parallel thread.

1. Thread the antenna cable through the antenna mount.
2. Align the screw holes in the antenna and the antenna mount. *Secure with the screws provided.*
3. Screw the mount onto the range pole.
4. Run the cable to the receiver installation, avoiding all sharp turns. Use nylon cable ties to secure the cable where needed.

Magnetic Mount of the Antenna

If you prefer, a magnetic antenna mount is available as an option. The magnetic mount is useful for temporarily mounting the antenna to any flat, metal surface.

The Global Positioning System

What Is GPS?

GPS is a constellation of navigation satellites that orbit the earth. The precise time and position information transmitted by these satellites is used by a GPS receiver to triangulate a position fix.

The system is now officially declared "initial operational," and provides continuous, 24-hour 3D (position plus elevation) coverage anywhere on the earth.

GPS was developed by the United States Department of Defense to provide consistent, reliable navigation information that is unaffected by rough terrain and bad weather, and is highly resistant to multipath errors and interference. The DoD continues to administer and control the Global Positioning System.

Although GPS was developed as a military navigation system, its civilian and commercial uses were recognized. The satellites therefore transmit two codes, a military-only encrypted code (PPS) and a civilian-access, Standard Positioning Service (SPS) code. All commercial and consumer GPS receivers are SPS receivers.

How Does GPS Work?

Each GPS satellite transmits its precise location (position and elevation) and the start time of the transmission. A GPS receiver acquires the signal, then measures the interval between transmission and receipt of the signal to determine the distance between the receiver and the satellite: this is ranging. Once the receiver has computed range for at least three satellites, its location on the surface of the earth can be determined.

Each satellite transmits two types of data, almanac and ephemeris. Almanac data is general information on the location and health of each satellite in the constellation. Since it contains general information, an almanac can be collected from any satellite. A receiver with a current almanac in its memory knows where in the sky to look for satellites, given its last known position and the time

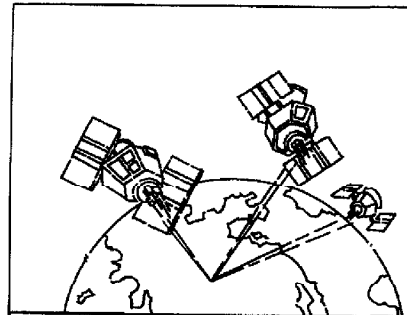

of day. Ephemeris data is the precise satellite positioning information that is used for ranging. Each satellite transmits its own ephemeris data.

Both almanac and ephemeris data are required for a GPS receiver to locate and acquire satellites quickly and compute a position fix.



Accuracy

GPS positioning with an SPS receiver that is intended for general use will produce accuracies of 25 meters or better.

In fact, SPS receivers have proven to be far more accurate than anyone anticipated. DoD has decided that 25-meter accuracy is a potential risk, and has introduced Selective Availability (SA) to maintain a military advantage. SA is a random error that is introduced to the SPS code ephemeris data and reduces the accuracy of any SPS receiver. The size of the error changes, but rarely exceeds 100 meters.

The DoD civil GPS user policy is that GPS accuracy as affected by SA is sufficient for general navigation. In an open environment, it usually is. Even with SA, a GPS receiver will bring you within visual range of a destination or target, and GPS remains the best available source of accurate, repeatable navigation and positioning information.

If you feel that you really need 25-meter accuracy, the effects of SA can be overcome with a technique called broadcast differential to produce highly accurate position fixes.

DGPS

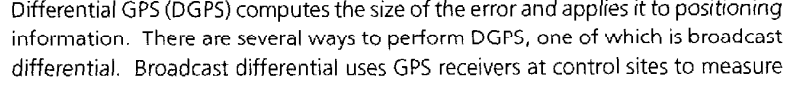

Differential GPS (DGPS) computes the size of the error and applies it to positioning information. There are several ways to perform DGPS, one of which is broadcast differential. Broadcast differential uses GPS receivers at control sites to measure the range errors for all visible satellites and determines a correction for each satellite. These corrections are broadcast in the RTCM SC-104 format by a radio beacon at the control site to any differential beacon receiver that is within range of the signal.

The differential beacon receiver receives and demodulates the signal, then relays it to the user's differential-ready GPS receiver. The user's GPS receiver applies the corrections to the positioning information it collects to compute differentially corrected position and navigation data.

This technique requires that your GPS receiver be connected to a compatible differential beacon receiver (such as the Magellan DBRT™, which is compatible with all differential-ready Magellan receivers). You must also be within range of a differential radio beacon.



More Information on GPS

There are many sources for more information on GPS and navigation. The sources listed here are just a few of the books, magazines, and Internet addresses that deal with GPS. Your local library is a good source for technical books on GPS and navigation.

GPS Information Center

The GPS Information Center provides general information on the Global Positioning System and satellite status. This center is operated by U.S. Coast Guard for the Department of Transportation, and was established to provide information and to serve as a point of contact for civilian GPS users.

- Voice telephone recording for constellation status: (703) 313-5907
- Computer bulletin board: (703) 313-5910 (up to 14,400 bps) (8 data bits, 1 stop bit, no parity)
- 24 hour operator: (703) 313-5900; fax: (703) 313-5920



A Comprehensive Guide to Land Navigation with GPS



An excellent book written by Noel J. Hotchkiss and published by Alexis Publishing. ISBN No: 0-9641273-2-6. This book uses the Magellan Trailblazer to discuss and describe land navigation with a GPS receiver. The book is very easy to read and gets into detail the art of navigating with GPS. (Available from Navtech Seminars.)

Newsgroups (Internet)

Several USENET newsgroups have occasional postings related to GPS. Some of the more popular newsgroups for GPS are:

- sci.geo.satellite-nav
- rec.aviation.products
- rec.boats
- sci.space
- sci.space.news



GPS World Magazine

Monthly magazine covering a wide variety of uses for GPS receivers.

Advanstar Communications
859 Willamette Street
Eugene, Oregon 97401
U.S.A.
Phone: (503) 343-1200
Subscriptions: 1-800-346-0085 x363

Other Books of Note:

Hofmann-Wellenhof, B., H. Lichtenegger, and J. Collins (1994). Global Positioning System, Theory and Practice. 3rd Edition. Springer-Verlag, 326 pp.

Institute of Navigation, The (1980). Global Positioning System. Vol. I. The Institute of Navigation (U.S.), 246 pp.

Institute of Navigation, The (1984). Global Positioning System. Vol. II. The Institute of Navigation (U.S.), 257 pp.

Institute of Navigation, The (1986). Global Positioning System. Vol. III. The Institute of Navigation (U.S.), 293 pp.

Institute of Navigation, The (1986). Global Positioning System. Vol. IV. The Institute of Navigation (U.S.), 378 pp.

Logsdon, T. (1992). Navstar Global Positioning System. Van Nostrand Reinhold, New York, 249 pp.

These books and others not mentioned can be purchased from Navtech Book and Software Store (a division of Navtech Seminars, Inc.). They can be reached at:

2775 S. Quincy St. #610
Arlington, VA 22206-2204
U.S.A.
Phone: (800) 628-0885
(703) 931-0500
Fax: (703) 931-0503





Glossary

Active Leg	The segment of a route currently being travelled.
Azimuth	The angular measurement from the horizon to a satellite or other object.
Backtrack	Retraces the position fixes (up to 21) stored automatically by the receiver every 10 minutes.
Bearing	The compass direction from your position to a destination, measured to the nearest degree.
Coordinates	A unique numeric or alphanumeric description of position.
Course	The direction in degrees from the start waypoint of a course line to its destination.
CTS	The optimum direction the vessel should be steered in order to efficiently make headway back to the course line while also proceeding toward the destination waypoint. It is a "compromise" course bearing that projects from your current position to a point on the course line mid-way between a point perpendicular to your position and the current leg destination waypoint.
Datum	Refers to the theoretical mathematical model of the earth's sea level surface. Map makers may use a different model to chart their maps from so positions will differ from one datum to another. The datum for the map you are using can be found in the legend of the map.
Elevation	Distance above or below mean sea level.
EPE	Estimated Position Error is the approximate error (between 0 and X) introduced in the ephemeris signal by the U.S. Department of Defense for reasons of security. This random error, known as Selective Availability (SA) is not due to receiver error and is not significant enough to affect navigation for most purposes (See DGPS in appendix).
Geometric Quality	Measures the probable accuracy of a position fix, based on the position of the satellites relative to each other.
GOTO	A single leg route with the present position being the start of the route and a defined waypoint as the destination. (If the unit has been moved while turned off and has not yet acquired a new position fix, the start of the GOTO will be the position fix last recorded.)





- Heading** The direction in which the receiver is moving, track or ground course, (due to wind, current, and so forth), and may also be different from the course.
- LAT/LON** Coordinate system using latitude and longitude coordinates to define a position on the earth.
- Latitude** The angular distance north or south of the equator measured by lines encircling the earth parallel to the equator in degrees from 0° to 90°.
- Last Fix** Position coordinates computed and stored automatically every 10 minutes in the Last Fix Buffer.
- Last Fix Buffer** The list of the most recent last fixes automatically stored by the receiver. (Up to 21 may be stored at one time.)
- Leg (Route)** A segment of a route that has a starting (FROM) waypoint and a destination (TO) waypoint. A route may consist of 1 or more legs. For a route that is from waypoint A to waypoint B, waypoint B to waypoint C, and waypoint point C to waypoint D has three legs with the first leg being from waypoint A to waypoint B.
- Longitude** The angular distance east or west of the prime meridian (Greenwich meridian) as measured by lines perpendicular to the parallels and converging at the poles from 0° to 180°.
- Magnetic North** The direction toward the north magnetic pole from the observer's position.
- OSGB** A coordinate system describing only Great Britain, similar to UTM's. Generally used with GBR36 datum, which also describes only Great Britain. This coordinate system cannot be used in any other part of the world. The Meridian XL and NAV 1200XL automatically selects the GBR36 datum when the OSGB coordinate system is selected in Setup. (While OSGB coordinates must be used with the GBR36 datum, the GBR36 datum can be used with LAT/LON coordinates; just be sure the map you are using uses both LAT/LON and GBR36.)
- Position Fix** Position coordinates as computed by the receiver.
- Reverse Route** Duplicates an existing route but in reverse order.



- 
- Route** A planned course of travel that is defined by a sequence of waypoints. When active, the route is used in the calculation of all navigation data except position, speed over ground and track/course over ground.
- Start and Destination Waypoint (FROM/TO)** Waypoints that mark the beginning and ending of a leg of a route.
- TDs** Coordinate system using lines of position determined by the Loran-C signals. Many coastal navigators use TDs because Loran is a familiar radio aid navigation and TDs are clearly marked on their charts. Your Magellan receiver can display position coordinates in TDs by converting from LAT/LON.
- Time To Go** The estimated time for the receiver to reach the destination from its current position based on the current VMG.
- True North** The direction to the geographical North Pole from an observer's position. The north direction on any geographical meridian.
- Track** The actual path travelled, which may differ from the planned course.
- Track History** The track over a selected length of time.
- UT** Universal Time, formerly referred to as Greenwich Mean Time (GMT).
- UTM** Universal Transverse Mercator (UTM) metric grid system used on most large and intermediate scale land topographic charts and maps.
- VMG** Velocity Made Good. The component of the velocity that is in the direction of the destination.
- Waypoint** A location saved in the unit's memory which is obtained by entering data, editing data, calculating data or saving a current position. Used to create routes.
- 

Index

- Abbreviations 66
- Accessories, optional 56
- Accuracy 4, 78
- Active Leg (navigating on) 38
- Alarms 47
- Antenna location 9, 73
- Backtrack, creating 40
- Batteries 72
 - Installing 72
 - Low Battery warning 53
- Baud rate 46
- CDI 24
- City reference chart 63
- Clear menu
 - Clearing a route 39
 - Clearing last fixes 51
 - Erase track 23
 - Erase waypoints 52
 - Clearing entire memory 52
- Clock 50
- Contrast 48
- Conventions used in this manual 2
- Coord Route 40
- Coord System 43, 69
- Customer service 55
- Customizing the
 - navigation screens 19
- Data terms, explanation 66
- Datums 45, 57
- DGPS 78
- Dist Units 45
- Elev Mode 43
- Elev Units 45
- External power 73, 74
- General Maintenance 72
- Global positioning system 77
- Glossary 81
- GOTO 14, 23, 31
 - Menu 31
 - MOB 39
 - Backtrack 40
 - Route (see Routes) 31
 - Coord
- Icons,
 - waypoint 25
 - arrow
- Initial Position Fix 10
- Initializing 5, 7, 42
- Inputting Data 16
- Installing Batteries
- Last Fixes 41
 - Trip summary 41
 - Lfix Interval 46
- Legs
 - Adding 37
 - Inserting 35
 - Leg edit menu 35
 - Viewing 35
 - Deleting 36
 - Replacing 38
 - Navigating 38
- Light Inten 48
- light ON/OFF 16
- Map Datum 45, 57
- MOB 39
- More information 79
- NAV 1 18, 20
- NAV 2 18, 20



NMEA 45, 55, 58

North Ref 45

ODOMETER 49

ON/OFF 15

OSGB 71

Packing list 1

PAN N SCAN 22

PLOT SETUP 46

Plot Scale 22

PLOT Screen 21

POINTER Screen 21

Position Fix

Initial 10

Saving as a Waypoint 11, 24

Position screen 17

POWER 4

Projecting waypoints 28

ROAD Screen 24

Routes 13

Activating/deactivating 34

Reversing 34

Clearing a route 39

Editing a route 35

Accessing route menu 32

Creating a multileg route 32

Viewing legs of a route 35

Inserting a leg 35

Deleting a leg 36

Replacing a leg 38

Navigating a leg 38

Sampling 47

Sat Status 49, 53

Setup Options 42

Simulator 51

Specifications 68

Speed Units 44

Status Line Icons 53

Sun/Moon screen 50

TDs 71

Time Format 44

Troubleshooting 54

UTM 69

Velocity Avg 44

Waypoints

Creating 26

Accessing the waypoint menu 26

Accessing the waypoint function
menu 28

Deleting 30

Editing 29

Projecting 28

Viewing 27

Sort 46

